



**WFUMB
CONGRESS
2022**
TIMIȘOARA
World Capital of Ultrasound

**18th World Federation
for Ultrasound in Medicine
and Biology Congress**



**EUROSON
CONGRESS
2022**

**33rd Congress of European
Federation of Societies for
Ultrasound in Medicine
and Biology**



**SRUMB
CONGRESS
2022**
SOCIETATEA ROMÂNĂ
DE ULTRASUNOGRĂFIE
ÎN MEDICINĂ ȘI BIOLOGIE

**25th National Conference
of Romanian Society of
Ultrasound in Medicine
and Biology**



**STUC
CONGRESS
2022**

**WFUMB-EFSUMB
Student Ultrasound Congress**
May 27 – 28, 2022

**MAY
25-28
2022**

Timișoara,
Romania



UNIVERSITATEA
DE MEDICINĂ ȘI FARMACIE
VICTOR BABES / TIMIȘOARA



EFSUMB



wfumb2022.com

**PROGRAM
BOOK**





TABLE OF CONTENTS

Welcome word	4
Invited speakers	6
Committees	10
Venue	14
Program at a glance	18
Scientific program	22
E-poster session	78
Recommendations for speakers and moderators	96
General information	98
Reasons to visit Timisoara	102
Notes	108

Dear colleagues and partners,

It is a great honor for Timișoara and for Romania to host the WFUMB Congress 2022.

The 18th World Federation for Medicine and Biology Congress in conjunction with the 2022 SRUMB Annual Conference and the EUROSON 2022, will be the most important event of the year for all of us using ultrasound as a medical tool.

It is also an opportunity to visit our beautiful town, “The Little Vienna” or “The City of Flowers”, as Timișoara is called, and to discover the Romanian hospitality.

WFUMB 2022 will maintain the tradition of a balanced program, including a range of postgraduate courses focused on different fields of ultrasound and will also bring the newest information in diagnostic and interventional ultrasonography, covering the usual broad range of topics.

The scientific committees assure you that WFUMB 2022 will be an excellent opportunity for continuous medical education for everyone, from the general practitioners to the scientists and researchers.

The local organizing committee and the Romanian Society of Ultrasound (SRUMB) are delighted to be your hosts and invite you to join this event, to explore the beauty of Timișoara and Romania, and to enjoy the special social events that will be prepared for this meeting.

For four days, between 25-28 May 2022 Timișoara will be The World Capital of Ultrasound.

We are looking forward to welcome you in Timișoara in 2022.

May 25-28, 2022
Timisoara, Romania

wfumb2022.com



Congress President
Prof. Ioan Sporea



WFUMB President
Prof. Cristina Chammas



EFSUMB President
Prof. Christian Jenssen



SRUMB President
Prof. Alina Popescu

Invited speakers

(in alphabetical order)

Jacques Abramowicz
USA

Iwaki Akiyama
Japan

Fernando Alfageme Roldán
Spain

Nihal Al-Riyami
Oman

Dominique Amy
France

Panos Ansaklis
Greece

Liat Appelbaum
Israel

Radu Badea
Romania

Kanu Bala
Bangladesh

Richard Barr
USA

Eva Bartels
Germany

Ramón Bataglia Araújo
Paraguay

Michael Blaivas
USA

Flaviu Bob
Romania

Simona Bota
Austria

Ciprian Brisc
Romania

Boris Brkljačić
Croatia

Peter Burns
Canada

Fabrizio Calliada
Italy

Georgiana Camen
Romania

Vito Cantisani
Italy

Durim Cela
Albania

Cristina Chammas
Brazil

Edda L. Chaves
Venezuela

Romeo Chira
Romania

Daniela Chiriac
Romania

Yi-Hong Chou
Taiwan

Anca Ciurea
Romania

Dirk André Clevert
Germany

George Condous
Australia

Peter Coombs
Australia

Adrian Costache
Romania

Diana Crișan
Germany

Simina Crișan
Romania

Mirko D'Onofrio
Italy

Mirela Dănilă
Romania

Christoph F Dietrich
Germany

Francesco Maria Drudi
Italy

Sorin Dudea
Romania

Oleh Dynnyk
Ukraine

Hazel Edwards
UK

Viorela Enăchescu
Romania

Bavuujav Erdenebileg
Mongolia

Caroline Ewertsen
Denmark

Leandro Fernandez
Venezuela

Giovanna Ferraioli
Italy

Daniela Fodor
Romania

Brian Fowlkes
USA

Diana Gaitini
Israel

Zsolt Garami
USA

Andres Garcia Bayce
Uruguay

Hassen Gharbi
Tunisia

Ioana Gheonea
Romania

Mirela Gliga
Romania

Adela Golea
Romania

Elene Gotsiridze
Georgia

Ivica Grgurevic
Croatia

Norbert Gritzmann
Austria

May 25-28, 2022
Timisoara, Romania

wfumb2022.com

Gail ter Haar
UK

Seung H Kim
South Korea

Suzan Elhakim
Sudan

György Harmat
Hungary

**Roald Flesland
Havre**
Norway

Odd Helge Gilja
Norway

Mihai Iacob
Romania

André Ignee
Germany

Byung Ihn Choi
South Korea

Adina Ionac
Romania

Ákos Járay
Hungary

Klaus-V. Jenderka
Germany

Christian Jensen
Germany

Fernando Jimenez
Spain

Mariana Jinga
Romania

Nicolaas de Jong
The Netherlands

Adnan Kabaalioğlu
Turkey

Stefan Kafwimbi
Zambia

**Constantin von
Kaisenberg**
Germany

**Joanna Kasznia-
Brown**
UK

Michael Kawooya
Uganda

Raymond Keshwan
Fiji

Milan Kocián
Czech Republic

Christian Kollmann
Austria

Mateusz Kosiak
Poland

Martin Krix
Germany

**Christian Borbjerg
Laursen**
Denmark

Mihai Lazăr
Romania

Won Jae Lee
South Korea

Daniel Lichtenstein
France

Adrian Lim
UK

Torben Lorentzen
Denmark

Jovan Lovrenski
Serbia

Andrej Lyshchik
USA

Giovanni Maconi
Italy

Claudiu Mărginean
Romania

**Patria Cecilia
Martinez**
Philippines

Gebhard Mathis
Austria

**Antonio Carlos
Matteoni de
Athayde**
Brazil

Jo McCann
New Zealand

Cătălina Mihai
Romania

Milija Mijajlovic
Serbia

Bogdan Miușescu
Romania

**Petru Adrian
Mircea**
Romania

Carmel Moran
UK

Cristian Mornoș
Romania

Călin Moș
Romania

Sebastian Müller
Germany

**Christian Pallson
Nolsøe**
Denmark

Dieter Nürnberg
Germany

Kim Nylund
Norway

**Suha Sureyya
Ozbek**
Turkey

Polina Pavićević
Serbia

Fabienne Perren
Switzerland

Corina Pienar
Romania

Massimo Pinzani
UK

Fabio Piscaglia
Italy

Monica Platon-Lupșor

Romania

Alina Popescu

Romania

Cristina-Mihaela Popescu

Romania

Bogdan Procopetș

Romania

Helmut Prosch

Austria

Serghei Puiu

Moldova

Bao Quan Nguyen Phuoc

Vietnam

Ivan Quiros

Peru

Jorge Rabat Salgh

Venezuela

Maija Radzina

Latvia

Matteo Rosselli

Italy

Adrian Săftoiu

Romania

Larisa Săndulescu

Romania

Blerina Saraci

Albania

Yusef Sayeed

USA

Mustafa Seçil

Turkey

Andrada Seicean

Romania

Oana Șerban

Romania

Paul Sidhu

UK

Roxana Șirli

Romania

Carolina Solomon

Romania

Raluca Șoșdean

Romania

Alexandros

Sotiriadis

Greece

Zeno Spârchez

Romania

Ioan Sporea

Romania

Adina Stan

Romania

Oana Stanciu

Romania

Dan Stănescu

Romania

Dana Stoian

Romania

Amir Seid Sultan

Ethiopia

Horia Ștefănescu

Romania

Plamen Todorov

Bulgaria

Tobias Todsén

Denmark

Ioan Tiberiu

Tofolean

Romania

Jan Tuma

Switzerland

Walter Uwe

Germany

Sudhir Vinayak

Kenya

Radu Vlădăreanu

Romania

William Yung Liang Wan

Taiwan

Hans-Peter

Weskott

Germany

Susan Westerway

Australia

Stephanie Wilson

Canada

Matthias Wüstner

Germany

Cem Yucel

Turkey

Pavlos Zoumpoulis

Greece



**Bracco, your partner
in diagnostic imaging**

welcomes you to the
WFUMB/EUROSON/SRUMB/STUC 2022
Annual Meeting!



www.braccoimaging.com



LIFE FROM INSIDE

Committees

Scientific Committee

Ioan Sporea
(Romania)
Congress President

Cristina Chammas
(Brazil)
WFUMB President,
Congress
Co-President

Christian Jenssen
(Germany)
EFSUMB President,
Congress
Co-President

Alina Popescu
(Romania)
SRUMB President,
Congress
Co-President

Seung H Kim
(South Korea)

**Antonio Carlos
Matteoni de
Athayde**
(Brazil)

Zeno Spârchez
(Romania)

Ciprian Brisc
(Romania)

**Jacques
Abramowicz**
(USA)

Julian Kuenzel
(Germany)

Titus Şuteu
(Romania)

Leandro Fernandez
(Venezuela)

Won Jae Lee
(South Korea)

Giovanna Ferraioli
(Italy)

Dan Stănescu
(Romania)

Sudhir Vinayak
(Kenya)

Dieter Nürnberg
(Germany)

Dominique Amy
(France)

Romeo Chira
(Romania)

George Condous
(Australia)

Roxana Şirli
(Romania)

Plamen Todorov
(Bulgaria)

Carolina Solomon
(Romania)

**Christian Pallson
Nolsøe**
(Denmark)

Caroline Ewertsen
(Denmark)

Daniel Lichtenstein
(France)

Cătălina Mihai
(Romania)

Yi-Hong Chou
(Taiwan)

Adrian Săftoiu
(Romania)

Fabio Piscaglia
(Italy)

Mirela Dănilă
(Romania)

**Christoph F.
Dietrich**
(Germany)

Helmut Prosch
(Austria)

Boris Brkljačić
(Croatia)

Daniela Chiriac
(Romania)

Odd Helge Gilja
(Norway)

Vito Cantisani
(Italy)

Viorela Enăchescu
(Romania)

Sorin Dudea
(Romania)

Paul Sidhu
(UK)

Adrian Lim
(UK)

Mirela Gliga
(Romania)

Adela Golea
(Romania)

Iwaki Akiyama
(Japan)

Maija Radzina
(Latvia)

Daniela Fodor
(Romania)

Dana Stoian
(Romania)

Sue Westerway
(Australia)

Christian Kollmann
(Austria)

**Petru Adrian
Mircea**
(Romania)

Mihai Iacob
(Romania)

Matthias Wüstner
(Germany)

Radu Badea
(Romania)

May 25-28, 2022
Timisoara, Romania

wfumb2022.com

Local Organizing Committee

Ioan Sporea

Alina Popescu

Roxana Şirli

Mirela Dănilă

Adrian Goldiş

Iulia Raţiu

Bogdan Miuşescu

Tudor Moga

**Anamaria
Ghiuchici**

Felix Bende

Ruxandra Mare

Camelia Foncea

**Andreea
Bărbulescu**

Alexandru Popa

Călin Burciu

Raluca Lupuşoru

Radu Cotrău

Greta Dancu

Darius Heredea

Adrian Burdan

Ariana Pascu

Patricia Lupulescu

Cristina Deiak

Andrei Ioniţoiu

Deiana Vuleţici

Oana Budii

Andreea Corobea

Andreea Braşovan

Christian Banciu

Monica Scorobete

Ramona Asăi



RS85 Prestige

Extindeți gama de observație a fluxului sanguin pentru a include viteze scăzute cu **MV-Flow™** astfel putând vizualiza microvascularizația în vederea creșterii încrederii în diagnostic.



Noua și inovativa tehnică de vizualizare tridimensională a fluxului sanguin, **LumiFlow™**, susține înțelegerea structurii vaselor de sânge precum și a direcționalității fluxului.



Obțineți rezultate cu un grad ridicat de încredere asupra cuantificării și evaluării gradului de fibroză hepatică cu ajutorul tehnologiei avansate **S-ShearWave Imaging™**.

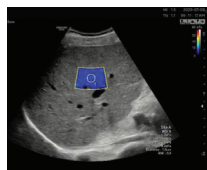

Grație noii tehnologii **CEUS+™** (Contrast Enhanced Ultrasound) puteți detecta și caracteriza facil leziuni cu ajutorul unor instrumente avansate precum graficul timp-intensitate.

THE REAL REVOLUTION

RS85 Prestige a revoluționat ecografia cu tehnologii noi și inovative cu aplicabilitate pentru orice tip de investigație.

Grație inteligenței artificiale și a celor mai complexe instrumente de analiză și diagnosticare, echipamentul definește noile standarde în ecografie.

Pachetele specializate de diagnosticare dezvoltate pe elemente hardware de ultimă generație transformă cele mai dificile cazuri clinice în examinări de rutină.



Experimentați noile metode non-invasive de cuantificare pentru ficatul gras, **TAI** (Tissue Attenuation Imaging) și **TSI** (Tissue Scatter distribution Imaging).

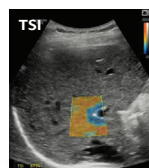
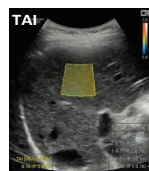

EzHRI™

Extindeți paleta metodelor de diagnosticare a ficatului gras cu ajutorul funcției **EzHRI™** ce efectuează automat calculul indexului hepato-renal.

Samsung's Quantification Tools for Fatty Liver

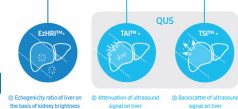



LEAD

WFUMB
CONGRESS
2022
TIMISOARA
World Capital of Ultrasound



Join the GE Ultrasound activities at EUROSON / WFUMB conference 2022

MEET us at the GE ULTRASOUND BOOTH

A solution for every need from Primary care, Point of Care and Multi-purpose Ultrasound solutions to the Vscan Air™, the GE wireless US probe device.

JOIN the 'GE LUNCH SYMPOSIUM'

Multi-parametric Ultrasound in the management of patients with Liver disease: from CLD to FLLs, from diagnostics to interventional procedures.

▶ **Friday, May 27th**
13:30 – 14:30 | Room 1

REGISTER to the 'GE EDUCATIONAL SESSIONS'

Explore the LEAD Educational program with hands-on workshops and lectures focused on a variety of care areas and advanced topics.

**REGISTER ▶
HERE**
or at the
GE BOOTH DESK



See you soon!

gehealthcare.com

© GE, 2022. Commercial availability of GE Healthcare medical systems is subject to meeting local requirements in a given country or region. Contact a GE Healthcare Representative for more information. GE, the GE Monogram and Vscan are trademarks of GE. JB05093XE

Venue

TIMISOARA
CONVENTION
CENTER

Marasesti street, no. 1-3
 300086, Timisoara
 Romania

Timisoara Hotel

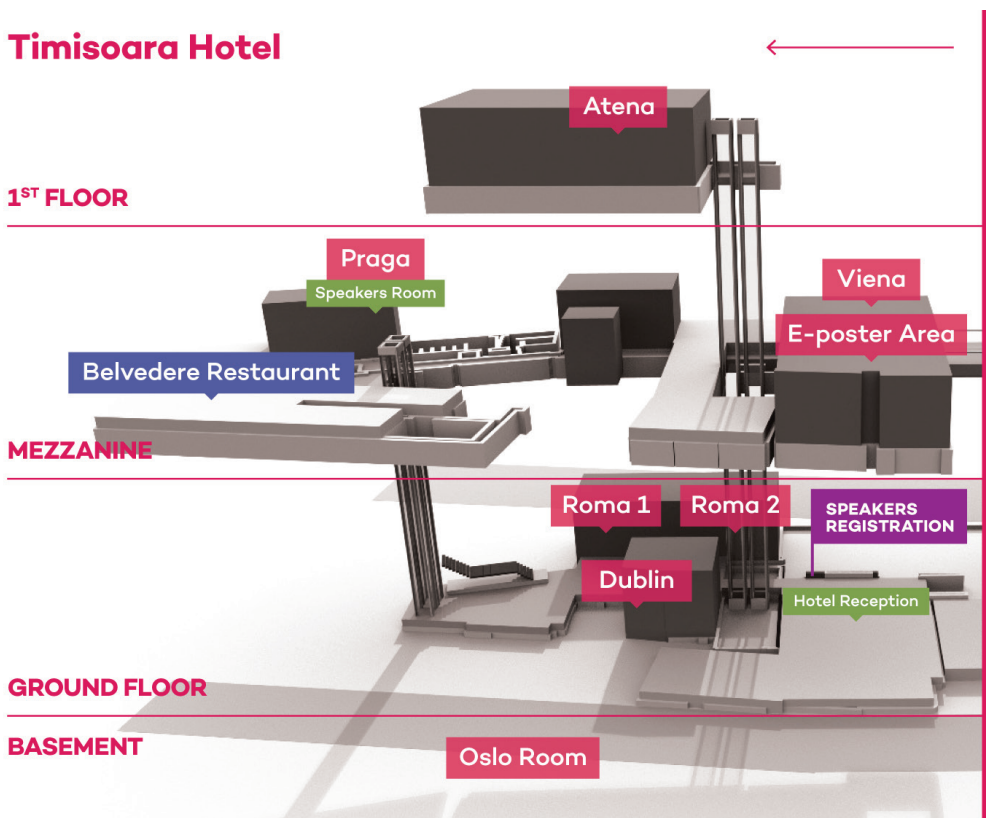

May 25-28, 2022
Timisoara, Romania

wfumb2022.com

Timisoara Convention Center

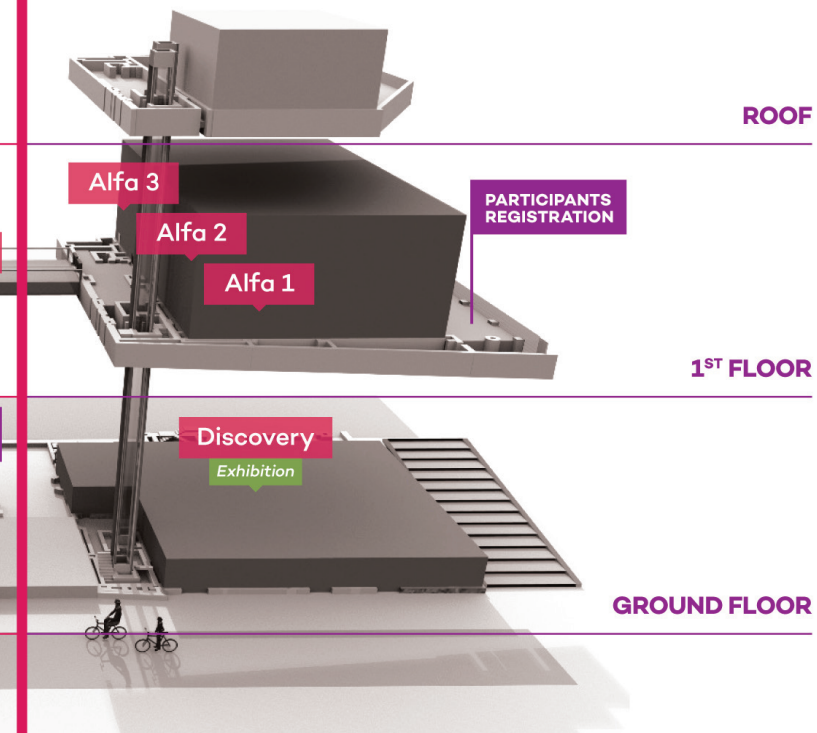

Exhibition area

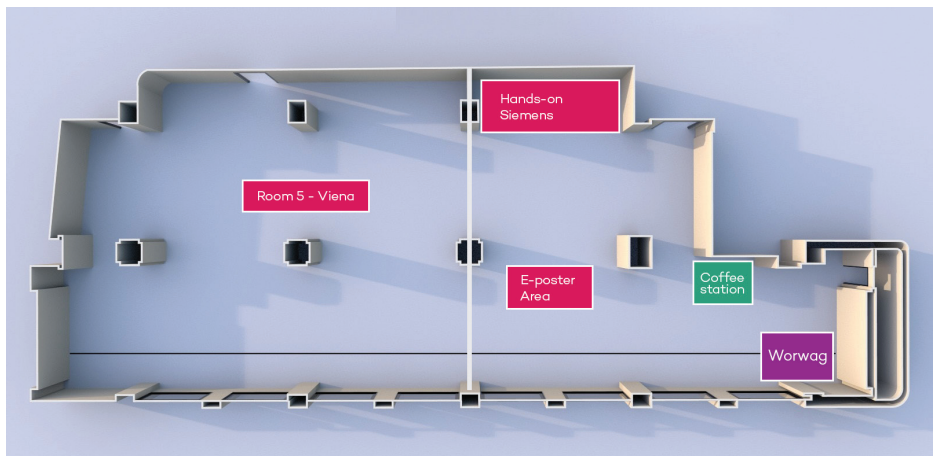
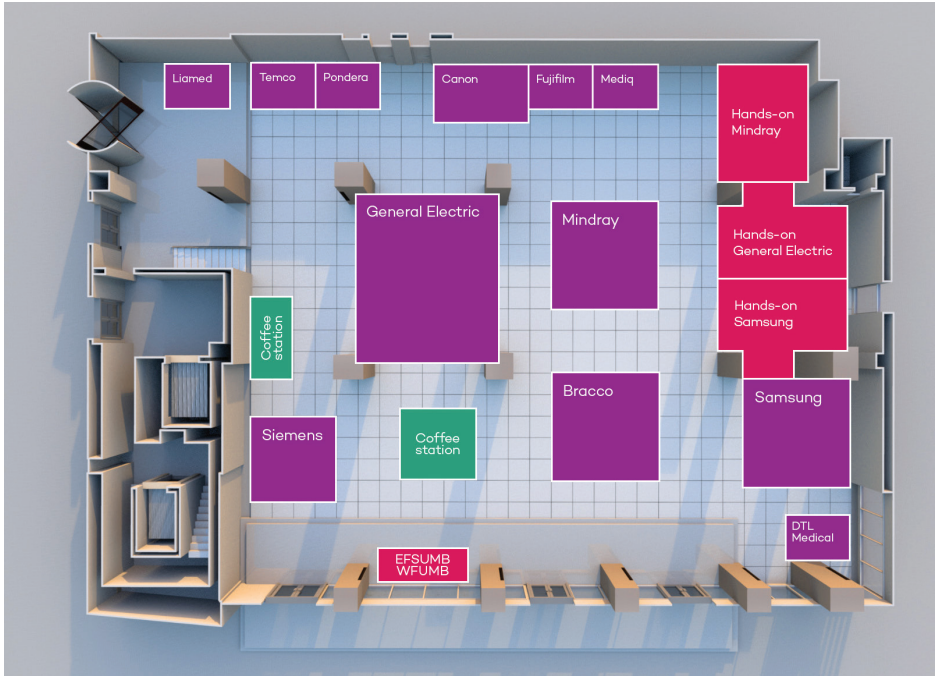

May 25-28, 2022
Timisoara, Romania

wfumb2022.com

Ground floor plan

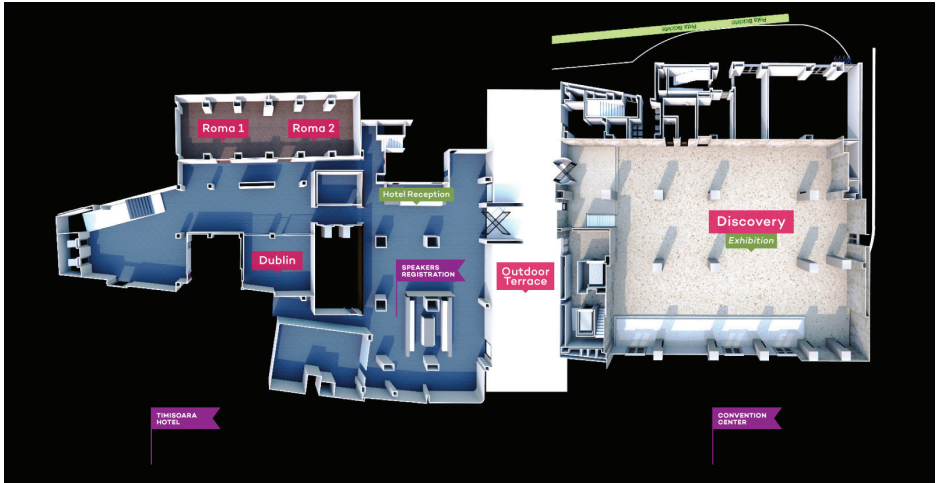

Mezzanine plan

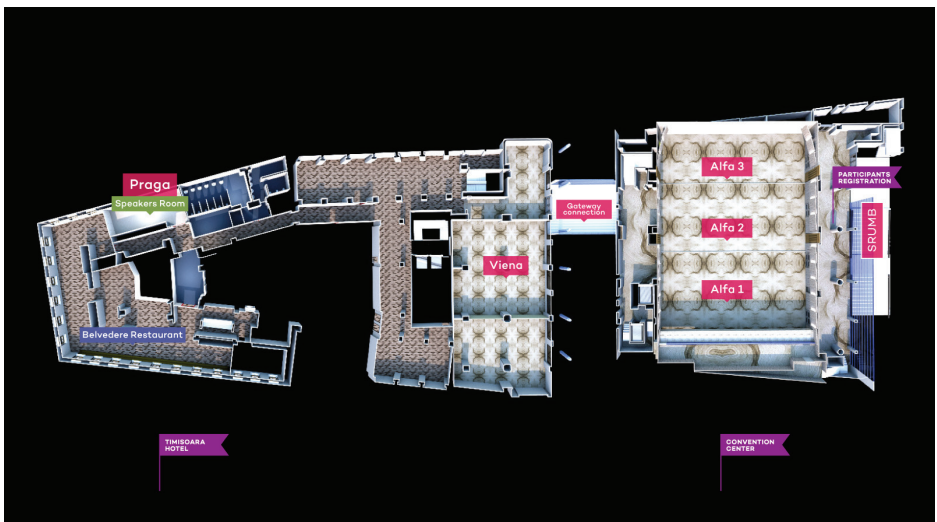

Program at a glance

Wednesday, May 25th / Pre-Congress Courses

Hour/Room	Room 1 - Alfa1	Room 2 - Alfa 2	Room 3 - Alfa 3	Room 4 - Atena	Room 5 - Viena	Room 6 - Roma 1	Room 7 - Roma 2	Room 8 - Oslo
09:00-11:00	Clinical US – US the key for the clinical decision Course directors: Christian Jenssen, Seung H Kim, Alina Popescu C1.1 Chairmen: Christian Jenssen, Alina Popescu	Musculoskeletal US Course directors: Daniela Fodor, Plamen Todorov C2.1 Musculoskeletal US - Upper Arm Chairmen: Daniela Fodor, Fernando Jimenez	Breast US Course directors: Dominique Amy, Dana Stoian C3.1 Chairmen: Dominique Amy, Dana Stoian	Emergency US Course directors: Adela Golea, Daniel Lichtenstein C4.1 US of Airway and Thorax (heart, lung, pleura) Clinical situation: failure and arrest Chairmen: Adela Golea, Daniel Lichtenstein	US for GP Course directors: Viorela Enăchescu, Radu Badea, Mihai Iacob C5.1 Chairmen: Viorela Enăchescu, Radu Badea	Obstetrics and Gynecology Course directors: Jacques Abramowicz Sudhir Vineyak C6.1 Chairmen: Jacques Abramowicz, Sergiu Puiu	Elastography from A to Z Course directors: Giovanna Ferraioli, Ioan Sporea Ioan Sporea C7.1 Chairmen: Giovanna Ferraioli, Ioan Sporea	Vascular US Course directors: Sorin Dudea, Dan Stănescu, Boris Brkljačić Ioan Sporea C8.1 Chairmen: Sorin Dudea, Dan Stănescu
11:00-11:30	Coffee break							
11:30-13:00	Clinical US – US the key for the clinical decision C1.2 Chairmen: Matthias Wüstner, Hans-Peter Weskott	Musculoskeletal US - Lower arm C2.2 Chairmen: Plamen Todorov, Ivan Quiros	Breast US C3.2 Chairmen: Boris Brkljačić, Dana Stoian	Emergency US C4.2 Trauma ultrasound and guided procedures Chairmen: Caroline Ewertsen, Adela Golea	US for GP C5.2 Chairmen: Radu Badea, Ioan Tofolean	Obstetrics and Gynecology C6.2 Chairmen: Gail ter Haar, Alexandros Sotiriadis	Elastography from A to Z C7.2 Chairmen: Giovanna Ferraioli, Ivica Grgurevic	Vascular US C8.2 Chairmen: Fabrizio Calliada, Sorin Dudea
13:00-15:00	Lunch							
15:00-17:00	US the key for the clinical decision C1.3 Chairmen: Christian Jenssen, Paul Sidhu	Musculoskeletal US - Miscellaneous C2.3 Chairmen: Christian Pallson, Naisee, Oana Șerban	Breast US C3.3 Chairmen: Dominique Amy, Andrej Lyshchik	Emergency US C4.3 Abdominal application of US in emergency Chairmen: Daniel Lichtenstein, Antonio Carlos Matteoni de Athayde	US for GP C5.3 Chairmen: Mihai Iacob, Mateusz Kosiak	Lunch 13:30 - 15:00 EFSUMB Board of Delegates Meeting	Elastography from A to Z C7.3 Chairmen: Ioan Sporea, Stephanie Wilson	Vascular US C8.3 Chairmen: Dan Stănescu, Dirk Andre Clevert
19:30-23:30	"Have a beer with ultrasound friends" at Curtea Berarilor 7: "Proclamația de la Timișoara" Street							

Thursday, May 26th
Day 1 congress

Hour/Room	Room 1 - Alfa 1	Room 2 - Alfa 2	Room 3 - Alfa 3	Room 4 - Atena	Room 5 - Viena	Room 6 - Roma 1	Room 7 - Roma 2	Room 8 - Oslo
09:00-11:00	S1. CEUS Liver Chairmen: Stephanie Wilson, Hans-Peter Weskott	S2. Lung US Chairmen: Helmut Prosch, Zeno Spârchez	S3. COE Timisoara - What is new in US? Chairmen: Ioan Sporea, Alina Popescu	S4. Breast Chairmen: Dominique Amy, Boris Brkljačić	S5. Testis Ultrasound Chairmen: Adnan Kabalioğlu, Mustafa Sevil	S6. Liver elastography Chairmen: Richard Barr, Sebastian Müller	S7. Echocardiography for non- cardiologist Chairmen: Adina Ionac, Cristian Marnoş	S8. Original research presentations Chairmen: Cristina Chammas, Christian Jenssen
11:00-11:30	Coffee break							
11:30-13:00	S9. Abdomen - Pancreas Chairmen: Mirko D'Onofrio, Mariana Jinga	S10. Musculoskeletal US and Rheumatology Chairmen: Daniela Fodor, Fernando Jimenez	S11. WFUMB Centers of Education Chairmen: Christian Pallson Nolsee, Leandro Fernandez, Odd Helge Gilja	S12. US in dermatology Chairmen: Fernando Diana Crişan	S13. Emergency US Chairmen: Milan Kocián, Fabio Piscaglia	S14. EFSUMB EPSC/JPub Comm Session Chairmen: Matthias Wüsthner & Zeno Spârchez	S15. Abdominal pediatric ultrasound Chairmen: Hassen A. Gharbi, Gyorgy Harmat	S16. Interactive clinical cases Chairmen: Petru Adrian Mircea, Ioan Tofolean
13:00-15:00	Lunch							
13:30-14:30	Bracco Lunch Symposium Clinical value of contrast enhanced ultrasound (CEUS) in liver imaging							
15:00-17:00	Special Lectures: EFSUMB1, EFSUMB2, DEGUM, Hans-Henrik Holm Chairmen: Christian Jenssen, Adrian Săftoiu	S17. Elastography - Nonhepatic applications Chairmen: Carolina Solomon, Caroline Ewertsen	S18. WFUMB Centers of Education Activity Report Chairmen: Odd Helge Gilja, Dieter Nürnberg	S19. Vascular US Chairmen: Diana Gaitini, Sorin Dudea	S20. US for GP Chairmen: Matteo Rosselli, Mateusz Kosiak	S21. INVUS Chairmen: Torben Lorentzen, Petru Adrian Mircea	S22. Obstetrics Chairmen: Panos Ansaklis, Nihal Al- Riyami	S23. Oral case reports Chairmen: Viorela Enăchescu, Mirela Gluga
18:30-20:30	Opening Ceremony - The Opera House							
20:30-22:00	Welcome Cocktail in the Exhibition - Hotel Timisoara							

Friday, May 27th / Day 2 Congress

Hour/Room	Room 1 - Alfa 1	Room 2 - Alfa 2	Room 3 - Alfa 3	Room 4 - Atena	Room 5 - Viena	Room 6 - Roma 1	Room 7 - Roma 2	Room 8 - Oslo
09:00-11:00	S24. GIUS 1 Chairmen: Christian Pallson Nolsee, Odd Helge Gilja	S25. Young Investigators Award - EFSUMB - Chairmen: Mathias Wuerstner, Zeno Sparchez	S26.CEUS Chairmen: Cristina Chammas, Akos Járay	S27. US of the thorax Chairmen: Helmut Prosch, Milan Kocián	S28. Imaging techniques in HCC Chairmen: Stephanie Wilson, Fabio Piscaglia	S29. US Therapies and More Chairmen: Iwaki Akiyama, Carmel Moran	S30. Prostate MPUS Chairmen: Francesco Maria Drudi, Dirk André Clevvert	
11:00-11:30	Coffee break							
11:30-13:00	S31. GIUS 2 Chairmen: Giovanni Macconi, Kim Nylund	S32. WFUMB Young Investigator Session - ECMUS Chairmen: Leandro Fernandez, Christian Pallson Nolsee	S33. Joint Safety Session: WFUMB - ECMUS Chairmen: Christian Kollmann, Brian Fowlkes	S34. US techniques in PHT Chairmen: Bogdan Procopet, Ivica Gigurevic	S35. Abdomen interventional US Chairmen: Liat Appelbaum, Cem Yucel	S36. Neonatal and Pediatric US Chairmen: Polina Pavičević, György Harmat	S37. EUS Chairmen: Roald Flesland Havre, Andrada Seicean	
13:00-15:00	Lunch							
13:30-14:30	General Electric Lunch Symposium Multi-parametric Ultrasound in the management of patients with Liver disease: from CLD to FLLs, from diagnostics to interventional procedures	Mindray Lunch Symposium The Art of innovation						
15:00-17:00	SRUMB - 25 years Chairmen: Ioan Sporea, Alina Popescu	S38. CEUS - nonliver applications Chairmen: Vito Cantisani, Brian Fowlkes	S39. New Trends in US (AI, Innovations) Chairmen: Christoph F Dietrich, Martin Krix	S40. Thyroid US Chairmen: Cristina Chammas, Elene Gotsiridze	S41. POCUS in nephro-urology Chairmen: Jan Tuma, Flaviu Bob	S42. Joint ESNCH /EFSUMB Session (European Society for Neurosonology and Cerebral Hemodynamics) Chairmen: Eva Bartels, Zsolt Garami	S43. US in Gynecology Chairmen: Claudiu Marginean, Sergiu Puiu	Hands-On Samsung
17:00-18:00	SRUMB General Assembly							
19:30-23:30	Get together party - Fratelli By The River 1. Corneliu Coposu Blvd							

Saturday, May 28th / Day 3 Congress

Hour/Room	Room 1 - Alfa 1	Room 2 - Alfa 2	Room 3 - Alfa 3	Room 4 - Atena	Room 5 - Viena	Room 6 - Roma 1	Room 7 - Roma 2	Room 8 - Oslo	
09:00-11:00	S44. Abdominal Emergencies Chairman: Adela Golea, Bao Quan Nguyen Phuoc	S45. 50 YEARS EFSUMB 1972-2022 Chairman: Christian Jenssen, Alina Popescu	S46. New US techniques in pediatrics (CEUS, Elasto) WFPI (World Federation of Pediatric Imaging) session Chairman: Joanna Kasznia-Brown, Andres Garcia Bayce	S47. INVUS Chairman: Romeo Chira, Ciprian Brisc	S48. Renal US Chairman: Richard Barr, Liat Appelbaum	S49. Head and Neck Chairman: Cristina Chammes, Tobias Tadsen	S50. Less known in US Chairman: Hassen A. Gharbi, Bogdan Procopet	09:00 - 12:00 Hands-On Mindray	
11:00-11:30	Coffee break								
11:30-13:30	S51. EFSUMB GIUS Guidelines - EFSUMB Recommendations and Guidelines For Gastrointestinal Ultrasound Chairman: Ioan Sporea, Matthias Wüstner	S52. Imaging in Fatty liver Chairman: Giovanna Ferraioli, Ivica Grigurevic	S53. Obstetrics and fetal malformations Chairman: Daniela Chiriac, Jacques Abramowicz	S54. EUS Chairman: Adrian Săftolu, Romeo Chira	S55. Vascular US Chairman: Andrej Lyshchik, Bogdan Procopet	S56. POCUS in endocrinology Chairman: Mustafa Seçil, Ivan Quiros	S57. Students' US education around the world Chairman: Roxana Şirli, Hassen A. Gharbi		
13:30-14:00	Closing Ceremony								

Scientific program

25th of May

Pre-Congress courses

Room 1 - Alfa 1

09:00-11:00	Clinical US – US the key for the clinical decision Course directors: Christian Jenssen, Seung H Kim, Alina Popescu C1.1 Chairmen: Christian Jenssen, Alina Popescu
09:00-09:20	Ultrasound the BEST in liver diseases Odd Helge Gilja (Norway)
09:20-09:40	A liver lesion was detected: should we always think of a tumor? Fabio Piscaglia (Italy)
09:40-10:00	Ultrasound the first line investigation in upper abdominal pain? Dieter Nürnberg (Germany)
10:00-10:20	Cystic pancreatic lesions – an ultrasound-guided algorithm for characterization and management (abdominal and endoscopic US) Christian Jenssen (Germany)
10:20-10:40	Problem Solving with CEUS in the Abdomen Stephanie Wilson (Canada)
10:40-11:00	Real-time ultrasound in jaundice - tips and tricks Adrian Săftoiu (Romania)
11:00-11:30	Coffee Break

11:30-13:00	Clinical US – US the key for the clinical decision C1.2 Chairmen: Matthias Wüstner, Hans-Peter Weskott
11:30-11:50	GI US with the curved probe – part of the normal abdomen scanning Matthias Wüstner (Germany)
11:50-12:10	Basics, advances and secrets of gastrointestinal ultrasound in emergencies Christoph F. Dietrich (Germany)
12:10-12:30	The role of ultrasound for the clinical decision in IBD Giovanni Maconi (Italy)
12:30-12:50	Can US differentiate between Non Hodgkin lymphoma and metastatic diseases? Hans-Peter Weskott (Germany)
13:00-15:00	Lunch
15:00-17:00	US the key for the clinical decision C1.3 Chairmen: Christian Jenssen, Paul Sidhu
15:00-15:20	US of the Urinary tract – the role for the clinical decision Seung H. Kim (South Korea)
15:20-15:40	US of the testis – the role for the clinical decision Paul Sidhu (UK)
15:40-16:00	LUS - CT correlation in parenchymal lung diseases Helmut Prosch (Austria)
16:00-16:20	“Just put a probe on it!” Adrian Lim (UK)
16:20-16:40	Ultrasound in abdominal pain in pediatrics Edda L. Chaves (Venezuela)
16:40-17:00	Integration of Point of Care Ultrasound Results into clinical decision making Michael Blaivas (USA)

Room 2 - Alfa 2

09:00-11:00	Musculoskeletal US Course directors: Daniela Fodor, Plamen Todorov C2.1 Musculoskeletal US - Upper Arm Chairmen: Daniela Fodor, Fernando Jimenez
09:00-09:25	Epicondyle pain ultrasound Fernando Jimenez (Spain)
09:25-09:50	Tumors and tumors-like of the hand and fingers Daniela Fodor (Romania)
09:50-10:15	Wrist and hand tenosynovitis - ultrasound findings Oana Șerban (Romania)
10:15-10:40	Ultrasound in Rotator Cuff lesions - from diagnosis to treatment Plamen Todorov (Bulgaria)
10:40-11:00	Understanding scanning ergonomics - how to avoid MSK injuries whilst scanning Sue Westerway (Australia)
11:00-11:30	Coffee Break
11:30-13:00	Musculoskeletal US - Lower arm C2.2 Chairmen: Plamen Todorov, Ivan Quiros
11:30-11:50	Achilles Tendon Ultrasound: All you need to Know Ivan Quiros (Peru)
11:50-12:10	Hamstring anatomy and injury Fernando Jimenez (Spain)
12:10-12:30	MRI Versus Ultrasound In Diagnosis Of In Knee Joint Injuries Durim Cela (Albania)
12:30-12:50	Ultrasound - a valuable diagnostic tool in knee osteoarthritis Plamen Todorov (Bulgaria)
13:00-15:00	Lunch

15:00-17:00	Musculoskeletal US - Miscellaneous C2.3 Chairmen: Christian Pallson Nolsøe, Oana Șerban
15:00-15:25	Sono-elastography of MSK and nerves Fabrizio Calliada (Italy)
15:25-15:50	Lumps & Bumps – Ultrasound from tip to toe Christian Pallson Nolsøe (Denmark)
15:50-16:15	Ultrasonography in the differential diagnosis of musculoskeletal inflammation Daniela Fodor (Romania)
16:15-16:40	US differential diagnosis of groin pain Fernando Jimenez (Spain)
16:40-17:00	Ultrasound aspect of bursitis Oana Șerban (Romania)

Room 3 – Alfa 3

09:00-11:00	Breast US Course directors: Dominique Amy, Dana Stoian C3.1 Chairmen: Dominique Amy, Dana Stoian
09:00-09:20	DaVinci code versus Ductal code Dominique Amy (France)
09:20-09:40	Physiological breast evolution Dominique Amy (France)
09:40-10:00	Ductal breast ultrasound technique Dana Stoian (Romania)
10:00-10:20	Breast US – current indications/limitations Adnan Kabaalioglu (Turkey)
10:20-10:40	Using ACR BI-RADS Lexicon Ultrasound Descriptors in Clinical Practice Sudhir Vinayak (Kenya)

10:40-11:00	Breast ultrasound in pregnancy and breastfeeding period Anca Ciurea (Romania)
11:00-11:30	Coffee Break
11:30-13:00	Breast US C3.2 Chairmen: Boris Brkljačić, Dana Stoian
11:30-11:48	Ultrasound features of different breast cancers Boris Brkljačić (Croatia)
11:48-12:06	Ultrasound in Gynecomastia Edda L. Chaves (Venezuela)
12:06-12:24	Ultrasound of breast implants Adrian Costache (Romania)
12:24-12:42	MV-flow imaging: New Doppler technology to investigate breast tumors Bao Quan Nguyen Phuoc (Vietnam)
12:42-13:00	Eco-guided FNA and Core Biopsy in Breast: Simple Methods Ivan Quiros (Peru)
13:00-15:00	Lunch
15:00-17:00	Breast US C3.3 Chairmen: Dominique Amy, Andrej Lyshchik
15:00-15:25	The clinical utility of advancing US technologies for breast imaging Adrian Lim (UK)
15:25-15:45	Doppler of the Breast Boris Brkljačić (Croatia)
15:45-16:10	Ultrasound lymphosonography for sentinel lymph node detection Andrej Lyshchik (USA)
16:10-16:35	Breast elastography Richard Barr (USA)

16:35-17:00 CEUS in breast tumors
Jan Tuma (Switzerland)

Room 4 - Atena

09:00-11:00 Emergency US
Course directors: Adela Golea, Daniel Lichtenstein
C4.1 US of Airway and Thorax (heart, lung , pleura) Clinical situation:
failure and arrest
Chairmen: Adela Golea, Daniel Lichtenstein

09:00-09:20 Usefulness of the transthoracic echocardiogram for the
ultrasonographer in the emergency: POCUS
Jorge Rabat Salgh (Venezuela)

09:20-09:40 The BLUE-protocol (lung ultrasound) for diagnosing acute respiratory
failure
Daniel Lichtenstein (France)

09:40-10:00 The FALLS-protocol: a suggested approach for diagnosing causes of
circulatory failure
Daniel Lichtenstein (France)

10:00-10:20 Pulmonary ultrasound utility in pediatric emergency
Jorge Rabat Salgh (Venezuela)

10:20-10:40 Point of Care Ultrasound advances in resuscitation
Michael Blaivas (USA)

10:40-11:00 Airway ultrasound in emergency practice
Adela Golea (Romania)

11:00-11:30 Coffee Break

11:30-13:00 Emergency US
C4.2 Trauma ultrasound and guided procedures
Chairmen: Caroline Ewertsen, Adela Golea

11:30-11:48 FAST ultrasound - how to do it
Caroline Ewertsen (Denmark)

11:48-12:06	eFAST & FATE: Techniques, Tips and Tricks Sudhir Vinayak (Kenya)
12:06-12:24	Value of eco fast in penetrating trauma of the chest and abdomen Jorge Rabat Salgh (Venezuela)
12:24-12:42	CEUS in Blunt Abdominal Trauma Paul Sidhu (UK)
12:42-13:00	Guided procedure in emergency Adela Golea (Romania)
13:00-15:00	Lunch
15:00-17:00	Emergency US C4.3 Abdominal application of US in emergency Chairmen: Daniel Lichtenstein, Antonio Carlos Matteoni de Athayde
15:00-15:20	Ultrasound in renal colic Jan Tuma (Switzerland)
15:20-15:40	Acute abdomen and occlusion Giovanni Maconi (Italy)
15:40-16:00	Acute diverticulitis - the role of ultrasound Alina Popescu (Romania)
16:00-16:20	Ultrasound in acute appendicitis Călin Moș (Romania)
16:20-16:40	US of Acute cholecystitis: what is new? Antonio Carlos Matteoni de Athayde (Brazil)
16:40-17:00	Pediatric acute abdominal and pelvic US György Harmat (Hungary)

Room 5 - Viena

09:00-11:00	US for GP Course Directors: Viorela Enăchescu, Radu Badea, Mihai Iacob C5.1 Chairmen: Viorela Enăchescu, Radu Badea
09:00-09:20	Ultrasonic imaging - physical basics and techniques Klaus-V. Jenderka (Germany)
09:20-09:40	Sonographically assessed physical examination in family medicine practice Mateusz Kosiak (Poland)
09:40-10:00	Pocus in Family Medicine Viorela Enăchescu (Romania)
10:00-10:20	Liver evaluation with ultrasound by Family Physicians. Rapid detection of NAFLD and its evolutionary stages toward cirrhosis in the targeted population through multiparametric liver ultrasonographic screening (MLUS) and artificial intelligence with fibrosis risk stratification by family physicians Mihai Iacob (Romania)
10:20-10:40	Differential diagnosis in focal liver lesions Larisa Săndulescu (Romania)
10:40-11:00	Pitfalls and errors in Biliary US Viorela Enăchescu (Romania)
11:00-11:30	Coffee Break
11:30-13:00	US for GP C5.2 Chairmen: Radu Badea, Ioan Tofolean
11:30-11:48	Kidney evaluation with the US in Family Medicine Jo McCann (New Zealand)
11:48-12:06	Differential diagnosis of jaundice Antonio Carlos Matteoni de Athayde (Brazil)



12:06-12:24	How difficult is the examination of the pancreas in transabdominal ultrasound - tips and tricks Radu Badea (Romania)
12:24-12:42	Ultrasound examination of the peritoneum and pouches. (Douglas, Morison, etc.) Ioan Tofolean (Romania)
12:42-13:00	“Just put a probe on it!” - for GP Adrian Lim (UK)
13:00-15:00	Lunch
15:00-17:00	US for GP C5.3 Chairmen: Mihai Iacob, Mateusz Kosiak
15:00-15:20	The thyroid ultrasound in Family Medicine practice. The Thyroscreen Project and Smart Thyroid Ultrasound Software, for the early diagnosis and risk stratification of thyroid pathology, guided by artificial intelligence in the family doctor’s office Mihai Iacob (Romania)
15:20-15:45	Limits of POCUS in Breast examination Georgiana Camen (Romania)
15:45-16:10	How will Artificial Intelligence change Point of Care Ultrasound in the future? Michael Blaivas (USA)
16:10-16:35	Lung sonography in family medicine - does it bring any value to everyday practice? Mateusz Kosiak (Poland)
16:35-17:00	Focused cardiac ultrasound (FOCUS) in Family Medicine. A prospective observational cross-sectional study with Focused cardiac ultrasound (FOCUS) along with the use of artificial intelligence conducted by the family physicians at patients with a high risk of cardiovascular diseases Mihai Iacob (Romania)

Room 6 - Roma 1

09:00-11:00	Obstetrics and Gynecology Course directors: Jacques Abramowicz, Sudhir Vinayak C6.1 Chairmen: Jacques Abramowicz, Sergiu Puiu
09:00-09:20	Screening for FGR or Fetal macrosomia and gestational diabetes Jacques Abramowicz (USA)
09:20-09:40	First trimester ultrasound screening for fetal structural anomalies Sergiu Puiu (Moldova)
09:40-10:00	Follow-up and delivery of FGR Alexandros Sotiriadis (Greece)
10:00-10:20	Obstetric ultrasound in multiple pregnancy Sue Westerway (Australia)
10:20-10:40	Cesarean scar pregnancy: diagnosis and management George Condous (Australia)
10:40-11:00	US of skeletal dysplasia –prenatal diagnosis Panos Ansaklis (Greece)
11:00-11:30	Coffee Break
11:30-13:00	Obstetrics and Gynecology C6.2 Chairmen: Gail ter Haar, Alexandros Sotiriadis
11:30-11:50	POCUS in obstetric trauma Jorge Rabat Salgh (Venezuela)
11:50-12:10	Safety of chorionic villus sampling and amniocentesis Alexandros Sotiriadis (Greece)
12:10-12:30	Ultrasound treatment of twin-twin transfusion Gail ter Haar (UK)
12:30-12:50	US or NIPT for DiGeorge Syndrome? Radu Vlădăreanu (Romania)

13:00-15:00	Lunch 13:30 - 15:00 - EFSUMB Board of Delegates Meeting
15:00-17:00	Obstetrics and Gynecology C6.3 Chairmen: Jacques Abramowicz, Sudhir Vinayak
15:00-15:25	Ultrasound screening for ovarian cancer Jacques Abramowicz (USA)
15:25-15:50	The role of imaging in congenital uterine anomalies Alexandros Sotiriadis (Greece)
15:50-16:10	Ideal classification system for pelvic endometriosis George Condous (Australia)
16:10-16:35	Detection and assessment of deep infiltrating endometriosis by routine pelvic ultrasound Sergiu Puiu (Moldova)
16:35-17:00	Ultrasound criteria in the diagnosis of PCO and PCOS Sudhir Vinayak (Kenya)

Room 7 - Roma 2

09:00-11:00	Elastography from A to Z Course Directors: Giovanna Ferraioli, Ioan Sporea C7.1 Chairmen: Giovanna Ferraioli, Ioan Sporea
09:00-09:20	Elastography: Physical background Giovanna Ferraioli (Italy)
09:20-09:40	Transient Elastography – technique and application in chronic viral hepatitis Monica Lupșor (Romania)
09:40-10:00	ARFI elastography techniques - pointSWE and 2D SWE techniques and application in chronic viral hepatitis Simona Bota (Austria)

10:00-10:20	Ultrasound based Elastography for Nonalcoholic Fatty Liver Disease Ioan Sporea (Romania)
10:20-10:40	US based elastographic assessment of fibrosis and steatosis in alcoholic liver disease Alina Popescu (Romania)
10:40-11:00	Elastography in autoimmune and cholestatic liver diseases Matteo Rosselli (Italy)
11:00-11:30	Coffee Break
11:30-13:00	Elastography from A to Z C7.2 Chairmen: Giovanna Ferraioli, Ivica Grgurevic
11:30-11:50	Ultrasound elastography for portal hypertension Ivica Grgurevic (Croatia)
11:50-12:10	Elastography for Hepatic Fibrosis: USE vs. MRE Byung Ihn Choi (South Korea)
12:10-12:30	An update on US-based elastography in pediatrics Corina Pienar (Romania)
12:30-12:50	Liver shear wave elastography: from the guidelines to the daily practice Giovanna Ferraioli (Italy)
13:00-15:00	Lunch
15:00-17:00	Elastography from A to Z C7.3 Chairmen: Ioan Sporea, Stephanie Wilson
15:00-15:20	Breast elastography Richard Barr (USA)
15:20-15:40	Pancreas elastography Adrian Săftoiu (Romania)
15:40-16:00	Ultrasound elastography of the prostate Sorin Ducea (Romania)

16:00-16:20 US-elastography of superficial organs: what we have learned by experience
Vito Cantisani (Italy)

16:20-16:40 Renal elastography- where are we now?
Flaviu Bob (Romania)

16:40-17:00 Sonography in IBD: the contributions of CEUS and Elastography
Stephanie Wilson (Canada)

Room 8 - Oslo

09:00-11:00 Vascular US
Course directors: Sorin Dudea, Dan Stănescu, Boris Brkljačić
C8.1
Chairmen: Sorin Dudea, Dan Stănescu

09:00-09:20 Vascular ultrasound in the era of CT and MRI
Boris Brkljačić (Croatia)

09:20-09:40 Basic vascular ultrasound - DVT
Jo McCann (New Zealand)

09:40-10:00 Doppler of peripheral arteries
Diana Gaitini (Israel)

10:00-10:20 Ultrasound evaluation of deep vein thrombosis
Cem Yucel (Turkey)

10:20-10:40 Is Doppler ultrasound reliable for the screening of hypertension in young patients
Mirela Gliga (Romania)

10:40-11:00 Using 3D Color Flow for True Umbilical Blood Flow
Brian Fowlkes (USA)

11:00-11:30 Coffee Break

11:30-13:00 Vascular US
C8.2
Chairmen: Fabrizio Calliada, Sorin Dudea

11:30-11:48	Portal system- hypertension and thrombosis Dieter Nürnberg (Germany)
11:48-12:06	Ultrasonography of superficial vascular tumors and anomalies Sorin Dudea (Romania)
12:06-12:24	Doppler Ultrasound diagnosis in some rare syndroms (splanchnic vascular stenosis or compression) Dan Stănescu (Romania)
12:24-12:42	Vector flow imaging: physics, actual and future possible applications Fabrizio Calliada (Italy)
12:42-13:00	Peliosis - Rare liver disease Christoph F. Dietrich (Germany)
13:00-15:00	Lunch
15:00-17:00	Vascular US C8.3 Chairmen: Dan Stănescu, Dirk Andre Clevert
15:00-15:20	CEUS in evaluation of vascular disease Vito Cantisani (Italy)
15:20-15:40	Low MI contrast harmonic imaging: Advances and limitations in liver and abdominal vascular disorders Hans Peter Weskott (Germany)
15.40-16:00	Contrast enhanced ultrasound of the abdominal aorta Dirk Andre Clevert (Germany)
16.00-16:20	CEUS for vascular liver abnormalities Zeno Spârchez (Romania)
16:20-16:40	CEUS and elastography for the assessments of vascular liver diseases Horia Ștefănescu (Romania)
16:40-17:00	Nutcracker phenomenon and nutcracker syndrom: Comparison of Doppler ultrasound and and CT findings Seung H Kim (South Korea)

26th of May

Room 1 - Alfa 1

09:00-11:00	S1. CEUS Liver Chairmen: Stephanie Wilson, Hans-Peter Weskott
09:00-09:20	CEUS: The Fundamentals of Liver Mass Interpretation Stephanie Wilson (Canada)
09:20-09:40	Contrast-enhanced US of the Liver on the basis of Sonazoid Yi-Hong Chou (Taiwan)
09:40-10:00	Clinical validation of CEUS LI-RADS in prospective multicenter trial Andrej Lyshchik (USA)
10:00-10:20	Difficulties in CEUS for benign focal liver lesions Roxana Şirli (Romania)
10:20-10:40	Advances of contrast enhanced B-Flow in liver diseases Hans-Peter Weskott (Germany)
10:40-11:00	Illustration of WFUMB CEUS liver guidelines Christoph F. Dietrich (Germany)
11:00-11:30	Coffee Break
11:30-13:00	S9. Abdomen – Pancreas Chairmen: Mirko D'Onofrio, Mariana Jinga
11:30-11:50	Early diagnosis of pancreatic cancer - role of Ultrasound techniques (abdominal and endoscopic US) Christian Jenssen (Germany)
11:50-12:10	Pancreatic cystic neoplasms Mirko D'Onofrio (Italy)
12:10-12:30	The role of EUS in evaluating pancreatic cystic lesions Mariana Jinga (Romania)
12:30-12:50	Ultrasound enhancement of immunotherapy for pancreatic cancer Gail ter Haar (UK)

12:50-13:00	OP 11. Shear-wave elastography versus Strain elastography with histogram analysis in solid pancreatic lesions: a pilot study Voicu Rednic (Romania)
13:00-15:00	Lunch
13:30-14:30	Bracco Lunch Symposium Clinical value of contrast enhanced ultrasound (CEUS) in liver imaging Moderator: Paul Sidhu Introduction: Role of CEUS in daily clinical practice Paul Sidhu Clinical value of CEUS in patients with suspected or proven HCC Carla Serra Clinical value of CEUS in patients with suspected or proven liver metastasis Hans-Peter Weskott Q&A
15:00-17:00	Special Lectures: EFSUMB1, EFSUMB2, DEGUM, Hans-Henrik Holm Chairmen: Christian Jenssen, Adrian Săftoiu
15:00-15:30	Urinary Tract Dilation Classification for Paediatric Urinary System EUROSON Honorary Lecture - Suha Sureyya Ozbek (Turkey)
15:30-16:00	Advances in parathyroid gland ultrasound EUROSON Honorary lecture - Maija Radzina (Latvia)
16:00-16:30	Setting up and improving standards for diagnostic imaging guidelines: the DEGUM approach DEGUM Lecture - Constantin von Kaisenberg (Germany)
16:30-17:00	Lung ultrasound: current concepts and future aspects Hans Henrik Holm Lecture - Christian Borbjerg Laursen (Denmark)
18:30-20:30	Opening Ceremony - The Opera House
20:30-22:00	Welcome Cocktail in the Exhibition - Hotel Timișoara

Room 2 - Alfa 2

09:00-11:00	S2. Lung US Chairmen: Helmut Prosch, Zeno Spârchez
09:00-09:20	Current misconceptions and latest updates in lung ultrasound Daniel Lichtenstein (France)
09:20-09:40	US pulmonar - Artificial intelligence applications in focal and diffuse lung diseases Romeo Chira (Romania)
09:40-10:00	Complex pulmonary consolidations. Pivotal role of CEUS and CEUS guided interventions Zeno Spârchez (Romania)
10:00-10:20	Percutaneous US in lung cancer staging Helmut Prosch (Austria)
10:20-10:40	Artificial Intelligence application to COVID-19 Lung Ultrasound evaluation Michael Blaivas (USA)
10:40-10:50	OP 1. Lung ultrasound in outpatients with covid-19 infection associated pneumonia. Haurylenka Dzmitry, Victar Damantsevich, Anna Damantsevich (Belarus)
10:50-11:00	OP 2. Accelerating Covid-19 Differential Diagnosis with Explainable Ultrasound Image Analysis: an AI Tool. Charlotte Buhre, Jannis Born, Nina Wiedemann, Manuel Cossio, Gabriel Brändle, Konstantin Leidermann, Avinash Aujayeb, Bastian Rieck, Karsten Bogwardt (Germany)
11:00-11:30	Coffee Break
11:30-13:00	S10. Musculoskeletal US and Rheumatology Chairmen: Daniela Fodor, Fernando Jimenez
11:30-11:48	Ultrasonography of the bone abnormalities - detection and pitfalls Daniela Fodor (Romania)

11:48-12:06	Particular ultrasound aspects in idiopathic inflammatory myopathies Carolina Solomon (Romania)
12:06-12:24	Work Related Musculoskeletal Injuries in Sonographers and Providers: Best Practices to Maintain Longevity and Improve Reporting Yusef Sayeed (USA)
12:24-12:42	Adul Hip Ultrasound: Main Pathology Imaging Ivan Quiros (Peru)
12:42-13:00	Calf injuries: beyond tennis leg Fernando Jimenez (Spain)
13:00-15:00	Lunch
13:30-14:30	Samsung Lunch Symposium WFUMB 2022 Samsung VIP Hands on Session “One Stop Shop” for the management of patients with NAFLD Opening Address: Ultrasound: “One stop shop” in hepatology Ioan Sporea (Romania) Hands on & practice: The “One Stop Shop” for the management of patients with chronic liver diseases Vito Cantisani (Italy)
15:00-17:00	S17. Elastography - Nonhepatic applications Chairmen: Carolina Solomon, Caroline Ewertsen
15:00-15:20	Up to date in breast elastography Dominique Amy (France)
15:20-15:40	Ehnaced TIRADS models strain versus shear wave - in the diagnostic of thyroid nodular disease Dana Stoian (Romania)
15:40-16:00	Evaluation of healthy muscle tissue by strain and shear wave elastography Caroline Ewertsen (Denmark)
16.00-16:20	Ultrasound and elastography compared with MRI in idiopathic inflammatory myopathies Carolina Solomon (Romania)

16:20-16:40	Elastography of the testis Dirk André Clevert (Germany)
16:40-17:00	Is there a place for elastography for nervs evaluation? Fabrizio Calliada (Italy)
18:30-20:30	Opening Ceremony - The Opera House
20:30-22:00	Welcome Cocktail in the Exhibition - Hotel Timișoara

Room 3 - Alfa 3

09:00-11:00	S3. COE Timisoara - What is new in US? Chairmen: Ioan Sporea, Alina Popescu
09:00-09:20	New technical developments in ultrasound Peter Burns (Canada)
09:20-09:45	Artificial intelligence in ultrasound Adrian Săftoiu (Romania)
09:45-10:10	Quantification of the fatty in the liver using imaging methods Ioan Sporea (Romania)
10:10-10:35	CEUS & Fusion & Interventional US – symbiotic triplets or useless gadgets? Christian Pallson Nolsøe (Denmark)
10:35-11:00	Of mice and men – the use of ultrasound in translational studies Carmel Moran (UK)
11:00-11:30	Coffee Break
11:30-13:00	S11. WFUMB Centers of Education Chairmen: Christian Pallson Nolsøe, Leandro Fernandez, Odd Helge Gilja
11:30-11:40	Perspectives on WFUMB CoE education Odd Helge Gilja (Norway)
11:40-12:00	How can e-learning help to develop education in WFUMB CoEs Caroline Ewertsen (Denmark)

May 25-28, 2022
Timisoara, Romania

wfumb2022.com

12:00-12:20	Guest Speaker: Experiences from teaching in remote underserved areas of Ethiopia Peter Coombs (Australia)
12:20-12:40	Future collaboration between WFUMB and IFMSA William Yung Liang (Taiwan)
12:40-13:00	Experiences and new ideas on handheld devices in CoEs Leandro Fernandez (Venezuela)
13:00-15:00	Lunch
15:00-17:00	S18. WFUMB Centers of Education Activity Report Chairmen: Odd Helge Gilja, Dieter Nürnberg
15:00-15:08	WFUMB COE Romania - Ioan Sporea
15:08-15:16	WFUMB COE Romania - WFUMB COE Venezuela - Leandro Fernandez
15:16-15:24	WFUMB COE Bangladesh - Kanu Bala
15:24-15:32	WFUMB COE Uganda - Michael Kawooya
15:32-15:40	WFUMB COE Ethiopia - Amir Sultan Seid
15:40-15:48	WFUMB COE Zambia - Stefan Kafwimbi
15:48-15:56	WFUMB COE Paraguay - Ramon Bataglia
15:56-16:04	WFUMB COE Sudan - Suzan Elhakim
16:04-16:12	WFUMB COE Moldova - Sergiu Puiu
16:12-16:20	WFUMB COE Vietnam - Bao Quan Nguyen Phuoc
16:20-16:28	WFUMB COE Albania - Blerina Saraci Qirinxhi
16:28-16:36	WFUMB COE Philippines - Patria Cecilia Martinez
16:36-16:44	WFUMB COE Fiji - Raymond Keshwan
16:44-16:52	WFUMB COE Peru - Ivan Quiros
16:52-17:00	WFUMB COE Mongolia - Bavuujav Erdenebileg

18:30-20:30 Opening Ceremony - The Opera House

20:30-22:00 Welcome Cocktail in the Exhibition - Hotel Timișoara

Room 4 - Atena

09:00-11:00 S4. Breast
Chairmen: Dominique Amy, Boris Brkljačić

09:00-09:20 Breast Lobar anatomy
Dominique Amy (France)

09:20-09:40 Doppler and Elastography of the Breast
Boris Brkljačić (Croatia)

09:40-10:00 Multimodal US in breast malignancies
Viorela Enăchescu (Romania)

10:00-10:20 Ductal hyperplasia- ultrasound and pathology
Adrian Costache (Romania)

10:20-10:40 Breast cancer screening in Asia
Yi-Hong Chou (Taiwan)

10:40-10:50 OP 3. Head-to-head comparison of perfluorobutane-contrast and multiparametric-mri for breast lesions: a prospective, Multicenter study
Manlin Lang (China)

11:00-11:30 Coffee Break

11:30-13:00 S12. US in dermatology
Chairmen: Fernando Alfageme Roldán, Diana Crișan

11:30-11:48 Dermatologic Ultrasound: What, How, Why, What for?
Fernando Alfageme Roldán (Spain)

11:48-12:06 Skin Vascular lesions: Ultrasound for diagnostic and vascular treatment
Leandro Fernandez (Venezuela)

May 25-28, 2022
Timisoara, Romania

wfumb2022.com

12:06-12:24	The increasing role of sonography in the preoperative setting in dermatologic surgery Diana Crişan (Germany)
12:24-12:42	The place of ultrasound and elastography in the management of patients with cutaneous melanoma Carolina Solomon (Romania)
12.42-13:00	Dermatologic Ultrasound: EFSUMB recommendations Fernando Alfageme Roldán (Spain)
13:00-15:00	Lunch
15:00-17:00	S19. Vascular US Chairmen: Diana Gaitini, Sorin Dudea
15:00-15:20	Carotid Artery Sonography Diana Gaitini (Israel)
15:20-15:40	Doppler ultrasound diagnosis of nutcracker phenomenon and nutcracker syndrome: technical tips Seung H. Kim (South Korea)
15:40-16:00	Ultrasonography of the post-thrombotic syndrome of the lower limb Sorin Dudea (Romania)
16.00-16:20	Minimal invasive procedure complication characterized by Doppler Dan Stănescu (Romania)
16:20-16:40	Doppler in erectile dysfunction Leandro Fernandez (Venezuela)
16:40-17:00	Budd Chiari syndrome Suzan Elhakim (Sudan)
18:30-20:30	Opening Ceremony - The Opera House
20:30-22:00	Welcome Cocktail in the Exhibition - Hotel Timișoara

Room 5 - Viena

09:00-11:00	S5. Testis Ultrasound Chairmen: Adnan Kabaalioglu, Mustafa Seçil
09:00-09:20	CEUS in scrotum testicular diseases Radu Badea (Romania)
09:20-09:40	Shear wave elastography in the normal and pathological testicle Călin Moș (Romania)
09:40-10:00	Scrotal US Adnan Kabaalioglu (Turkey)
10:00-10:20	Scrotal inflammatory conditions Mustafa Seçil (Turkey)
10:20-10:40	Paratesticular lesions Mustafa Seçil (Turkey)
10:40-10:50	OP 4. Selecting patients for embolization of varicoceles based on ultrasonography. Izabela Dąbrowska (Poland)
11:00-11:30	Coffee Break
11:30-13:00	S13. Emergency US Chairmen: Milan Kocián, Fabio Piscaglia
11:30-11:48	Critical ultrasound, a holistic discipline when lung ultrasound is incorporated Daniel Lichtenstein (France)
11:48-12:06	Bedside US to detect abdominal bleeding complications Fabio Piscaglia (Italy)
12:06-12:24	Ultrasound Monitoring of the gastrointestinal tract function in the ICU Milan Kocián (Czech Republic)
12:24-12:42	CEUS in the ICU – promising applications for daily practice Milan Kocián (Czech Republic)

12:42-13:00	CEUS in acute and critical patients (with special focus on vascular complications) Radu Badea (Romania)
13:00-15:00	Lunch
13:30-14:00	Siemens Breaking News: Novel Technologies on Liver Fat Quantification and Stiffness assessment Alina Popescu (Romania)
15:00-17:00	S20. US for GP Chairmen: Matteo Rosselli, Mateusz Kosiak
15:00-15:20	The management of gallbladder polyps Mirela Dănilă (Romania)
15:20-15:40	Ultrasound diagnosis of chronic liver disease and mimics of cirrhosis Matteo Rosselli (Italy)
15:40-16:00	Incidental findings in abdominal US Christoph F. Dietrich (Germany)
16:00-16:20	Early detection of cancers in family medicine practice - what can be achieved with sonography? Mateusz Kosiak (Poland)
16:20-16:40	Urinary US: the role for the GP Adnan Kabaalioğlu (Turkey)
16:40-17:00	The Point of Care Ultrasonography at the Family Physicians' daily practice - a prospective observational cross-sectional study at the patients presenting with medical emergencies in primary healthcare Mihai Iacob (Romania)
18:30-20:30	Opening Ceremony - The Opera House
20:30-22:00	Welcome Cocktail in the Exhibition - Hotel Timișoara

Room 6 - Roma 1

09:00-11:00	S6. Liver elastography Chairmen: Richard Barr, Sebastian Müller
09:00-09:20	Pitfalls in liver elastography Roxana Şirli (Romania)
09:20-09:40	Ultrasound based elastography for alcohol induced liver disease Sebastian Müller (Germany)
09:40-10:00	Liver and spleen elastography in the monitoring of portal hypertension Massimo Pinzani (UK)
10:00-10:20	Liver elastography — update on SRU guidelines Richard Barr (USA)
10:20-10:30	OP 5. Liver stiffness as assessed by two-dimensional shear wave elastography is associated with adverse clinical outcomes of patients with compensated chronic liver disease Kristian Podrug, Mrko Lucijanic, Ida Tjesic Drinkovic, Tonci Bozin, Tomislav Bokun, Ivica Grgurevic (Croatia)
10:30-10:40	OP 6. Performance of p-SWE and 2D-SWE with three probes from a new ultrasound machine for the prediction of advanced liver fibrosis using transient elastography as a reference method Ioan Sporea, Raluca Lupusoru, Roxana Şirli, Felix Bende, Alexandru Popa, Radu Cotrau, Alina Popescu (Romania)
10:40-10:50	OP 7. Factors affecting assessment of liver steatosis with quantitative ultrasound Aladár Rónaszéki, Bettina K. Budai, Robert Stollmayer, Steiner Tidhar, Pál Maurovich-Horvat, Pál N. Kaposi (Hungary)
10:50-11:00	OP 8. Clinical evaluation of viscoelasticity measurements by shear wave elastography in healthy and chronic liver disease subjects Roxana Şirli, Alexandru Popa, Alina Popescu, Felix Bende, Renata Fofiu, Victor Baldea, Radu Cotrau, Camelia Foncea, Ariana Pascu, Ioan Sporea (Romania)
11:00-11:30	Coffee Break

May 25-28, 2022
Timisoara, Romania

wfumb2022.com

11:30-13:00	S14. EFSUMB EPSC/Pub Comm Session Chairmen: Matthias Wüstner & Zeno Spârchez
11:30-11:50	EFSUMB Professional Standards Paper Matthias Wüstner (Germany)
11.50-12:10	EFSUMB Head & Neck Training Recommendations Tobias Todsén (Denmark)
12.10-12:25	Who is doing your scan? - the clinician perspective Alina Popescu (Romania)
12:25-12:40	Who is doing your scan? - the sonographer perspective Hazel Edwards (UK)
12:40-12:55	Who is doing your scan? - the radiologist perspective Torben Lorentzen (Denmark)
13:00-15:00	Lunch
15:00-17:00	S21. INVUS Chairmen: Torben Lorentzen, Petru Adrian Mircea
15:00-15:20	Interventional ultrasound - how I do it Christian Pallson Nolsøe (Denmark)
15:20-15:40	Seeding after US-guided biopsy Torben Lorentzen (Denmark)
15:40-16:00	US Guided Interventions – on the way to “Sono Surgery” Matthias Wüstner (Germany)
16:00-16:20	Complications after US guided interventions. Role of CEUS in the diagnosis and treatment Zeno Spârchez (Romania)
16:20-16:40	FNAB US-guided: Techniques and indications for thyroid nodules Cristina Chammas (Brazil)
16:40-17:00	Ultrasound guided ablation of thyroid nodules Cem Yucel (Turkey)
18:30-20:30	Opening Ceremony - The Opera House

20:30-22:00 Welcome Cocktail in the Exhibition - Hotel Timișoara

Room 7 - Roma 2

09:00-11:00 S7. Echocardiography for non-cardiologist
Chairmen: Adina Ionac, Cristian Mornoș

09:00-09:20 Focus cardiac ultrasound in the emergency room
Simina Crișan, (Romania)

09:20-09:40 Echocardiography for the oncological patient
Cristian Mornoș (Romania)

09:40-10:00 Echocardiography for patients with Chronic Kidney Disease
Adina Ionac (Romania)

10:00-10:20 Echocardiography for the screening of cardiovascular abnormalities in athletes
Raluca Sosdean (Romania)

10:20-10:40 Lung ultrasound imaging – a standard for pulmonary evaluation
Mihai Lazăr (Romania)

10:40-10:50 OP 9. Echocardiographic findings in a chronic kidney disease cohort
Maria Daniela Teodora, Daniel Cosmin Caragea, Kamal Constantin Kamal (Romania)

10:50-11:00 OP 10. Left atrial dysfunction by speckle tracking echocardiography in young subjects with hiv infection
Ioana Mirea, Ionut Donoiu, Mirela Mănescu, Florentina Dumitrescu, Octavian Istratoaie, Constantin Militaru (Romania)

11:00-11:30 Coffee Break

11:30-13:00 S15. Abdominal pediatric ultrasound
Chairmen: Hassen A. Gharbi, György Harmat

11:30-11:50 Pediatric US in oncology diagnosis and follow up
György Harmat (Hungary)

May 25-28, 2022
Timisoara, Romania

wfumb2022.com

11:50-12:10	Usefulness of ultrasonography in children with right iliac fossa pain Polina Pavićević (Serbia)
12:10-12:30	Abdominal US incidentaloma in children Corina Pienar (Romania)
12:30-12:50	What's left to US urinary tract in children? Hassen A. Gharbi (Tunisia)
13:00-15:00	Lunch
15:00-17:00	S22. Obstetrics Chairmen: Panos Ansaklis, Nihal Al-Riyami
15:00-15:20	Ultrasound in preeclampsia Alexandros Sotiriadis (Greece)
15:20-15:40	Doppler-beyond the umbilical artery Jacques Abramowicz (USA)
15:40-16:00	Ultrasound assessment of the fetal behavior Panos Ansaklis (Greece)
16:00-16:20	Ultrasound in the 1st trimester of pregnancy Ramon Bataglia (Paraguay)
16:20-16:40	Second Trimester Anomaly Fetal scan Nihal Al-Riyami (Oman)
16:40-17:00	The reduction of maternal mortality in Zambia: What role is ultrasound playing? Stefan Kafwimbi (Zambia)
18:30-20:30	Opening Ceremony - The Opera House
20:30-22:00	Welcome Cocktail in the Exhibition - Hotel Timișoara

Room 8 – Oslo

- 09:00-11:00** S8. Original research presentations
Chairmen: Cristina Chammas, Christian Jenssen
-
- 09:00-09:10** OP 34. Optical and ultrasound imaging of shear wave generated by laser induced cavitation bubbles
Saber Izak Ghasemian, Fabian Reuter, Claus-Dieter Ohl (Germany)
-
- 09:10-09:20** OP 35. Detection of a spoke-wheel pattern of focal nodular hyperplasia with novel microvascular flow imaging
Aladár Rónaszéki, Bettina K. Budai, Robert Stollmayer, Gabriella Györi, Pál Maurovich-Horvat, Pál N. Kaposi (Hungary)
-
- 09:20-09:30** OP 36. 3D ultrasound versus computed tomography as ex-vivo imaging of surgical specimens – a pilot study on animal specimen
Fatemeh Makouei, Caroline Ewertsen, Tina KlitmÅ, Iler Agander, Mikkel Vestergaard Olesen, Bente Pakkenberg, Tobias Todsén (Denmark)
-
- 09:30-09:40** OP 37. Diagnostic accuracy of Controlled Attenuation Parameter for steatosis assessment in chronic liver diseases using the M and the XL probes
Teodora Șerban, Alexandra-Iulia Silion, Monica Platon-Lupușor (Romania)
-
- 09:40-09:50** OP 38. Fatty liver quantification using Ultrasound Derived Fat Fraction (UDFF) as compared to Controlled Attenuation Parameter (CAP) in a mixed cohort of patients
Ioan Sporea, Raluca Lupușoru, Roxana Șirli, Felix Bende, Radu Cotrau, Camelia Foncea, Alina Popescu (Romania)
-
- 09:50-10:00** OP 39. Multiparametric ultrasound evaluation of liver fibrosis, steatosis and viscosity in patients with chronic liver disease
Iulia Minciuna, Madalina Taru, Oana Nicoara Farcau, Monica Platon-Lupușor, Horia Ștefănescu, Bogdan Procopet (Romania)
-
- 10:00-10:10** OP 40. Applicability of viscosity plane-wave ultrasound (ViPlus) in the evaluation of thyroid gland in healthy volunteers
Diana-Raluca Petea-Balea, Carolina Solomon, Sorin Dudea, Delia Muntean (Romania)
-
- 10:10-10:20** OP 41. The strain ratio and 4D vascularity as additional parameters to the TI-RADS
Andreea Borlea, Laura Cotoi, Ioan Sporea, Dana Stoian (Romania)

10:20-10:30	OP 42. The relationship of renal stiffness measured using 2D shear wave elastography and renal function in kidney transplant recipients Felix-Mihai Maralescu, Flaviu Bob, Alina Popescu, Roxana Şirli, Adalbert Schiller, Ligia Petrica (Romania)
10:30-10:40	OP 43. Pitfalls in renal artery stenosis ultrasound examination Gliga Mirela, Adriana Gomotirceanu, Ioan Tilea, Mihai Gliga, Paula Chirila, Cristian Chirila (Romania)
10:40-10:50	OP 44. Ultrasound-Based Radiomics Nomogram for Differentiating Benign and Malignant Solid Kidney Tumours Wu Gege, Xin-Wu Cui, Christoph F. Dietrich (China)
11:00-11:30	Coffee Break
11:30-13:00	S16. Interactive clinical cases Chairmen: Petru Adrian Mircea, Ioan Tofolean
11:30-11:50	Interesting ultrasound cases Ioan Tiberiu Tofolean (Romania)
11:50-12:10	Interesting ultrasound cases Romeo Chira (Romania)
12:10-12:30	Interesting OBG ultrasound cases Sergiu Puiu (Moldova)
12:30-12:50	Interesting ultrasound cases Felix Bende, Roxana Şirli, Mirela Dănilă, Ioan Sporea (Romania)
13:00-15:00	Lunch
15:00-17:00	S23. Oral case reports Chairmen: Viorela Enăchescu, Mirela Gliga
15:00-15:10	OCR1. Difficulties in the ultrasonographic diagnosis of a gallbladder tumor Radu-Cristian Cimpeanu, Larisa Daniela Sandulescu, Cosmin Vasile Obleaga, Corina Gruia, Ion Rogoveanu, Cristin-Constantin Vere (Romania)

15:10-15:20	OCR2. An ultrasound “surprise” mediastinal mass – thymic Hodgkin’s lymphoma Mihaela Tanco, Ioan Tiberiu Tofolean (Romania)
15:20-15:30	OCR3. Ultrasound assessment of hepatic post-traumatic injuries in patients with cardiac disease Maria-Cristina Bezna, Marinela Bezna, Carmen-Daniela Neagoe, Sergiu-Marian Cazacu, Roxana-Andreea Baran, Lorena Ungureanu (Romania)
15:30-15:40	OCR4. An unusual CEUS finding in a patient with carcinoid syndrome Elena Codruta Gheorghe, Maria Stoica, Anca Dimitriu, Daniela Elena Burtea, Nona Bejinariu, Adrian Săftoiu (Romania)
15:40-15:50	OCR5. The role of ultrasonography and added value of contrast-enhanced ultrasonography in emergency diagnosis of ruptured hydatid cysts - a case report Elena Simona Ioanițescu, Otilia Motoi, Emil Matei, Gabriela Postolea, Cătălin Rusu, Elena Laura Iliescu (Romania)
15:50-16:00	OCR6. Contrast-enhanced ultrasonography in diagnosis and follow up of pancreatic pseudoaneurysm – case report Sevastita Iordache, Laurentiu Gulie, Andreea Crasan, Cristian Constantin, Larisa Sandulescu, Sergiu Cazacu, Adrian Săftoiu (Romania)
16:00-16:10	OCR7. A rare and unexpected case of intestinal obstruction - gallstone ileus Mihaela Tanco, Ioan Tiberiu Tofolean (Romania)
16:10-16:20	OCR8. Diagnostic accuracy of contrast enhanced ultrasound in malignant thyroid nodule – case report Andreea Toma, Mihaela Vlad, Ioana Golu, Marioara Cornianu, Carmen Dorogi, Tudor Moga (Romania)

May 25-28, 2022
Timisoara, Romania

wfumb2022.com

16:20-16:30 OCR11. Importance of standard abdominal ultrasonography in incidental diagnosis of pseudomyxoma peritonei in a poor symptomatic patient

Camelia - Cristiana Bigea, Maria-Lorena Ungureanu, Mihaela-Roxana Cituran, Alexandra-Georgiana Bocioaga, Ion Rogoveanu, Carmen-Daniela Neagoie (Romania)

16:30-16:40 OCR12. Abdominal ultrasound: the most useful method in diagnosing a rare case of Wilkie's syndrome

Laura Savu, Corina Pienar, Liviu Laurentiu Pop, Corina Cercel, Lorena Asofronei, Mirela Mogoi (Romania)

18:30-20:30 Opening Ceremony - The Opera House

20:30-22:00 Welcome Cocktail in the Exhibition - Hotel Timișoara

27th of May

Room 1 - Alfa 1

09:00 -11:00	S24. GIUS 1 Chairmen: Christian Pallson Nolsøe, Odd Helge Gilja
09:00-09:20	The world's first guidelines on gastrointestinal ultrasound Odd Helge Gilja (Norway)
09:20-09:40	Diverticular disease and diverticulitis Giovanni Maconi (Italy)
09:40-10:00	Treatment response in IBD Kim Nylund (Norway)
10:00-10:20	TRUS applications in anal and rectal diseases Christian Pallson Nolsøe (Denmark)
10:20-10:40	Transrectal US in staging of early rectal cancer Torben Lorentzen (Denmark)
10:40-10:50	OP 12. The role of Dynamic Contrast Harmonic Imaging Endoscopic Ultrasound (CHI-EUS) and CD105 and CD31 immunostaining in tumor angiogenesis assessment on patients with gastric cancer – a feasibility study Victor Mihai Sacerdotianu, Bogdan Silviu Ungureanu, Sevastita Iordache, Ion Rogoveanu, Adrian Săftoiu, Tudorel Ciurea (Romania)
11:00-11:30	Coffee Break
11:30-13:00	S31. GIUS 2 Chairmen: Giovanni Maconi, Kim Nylund
11:30-11:50	Transabdominal ultrasound of the ileo-coecal valve Odd Helge Gilja (Norway)
11:50-12:05	Score development in IBD Kim Nylund (Norway)

12:05-12:25	Functional GI disorders Giovanni Maconi (Italy)
12:25-12:40	Transrectal US guided treatment of abscesses in lower abdomen Torben Lorentzen (Denmark)
12:40-12:50	OP17. Evaluation of fibrotic and inflammatory stricture in the terminal ileum with Shear Wave Elastography (SWE) in Chron's Disease Mustafa Devran Aybar (Turkey)
12:50-13:00	OP18. GIUS + CEUS vs. entero-RM in assessing the severity of ileal Crohn's Disease: a feasibility study Razvan - Cristian Statie, Sevastița Iordache, Lucian-Mihai Florescu, Ioana-Andreea Gheonea, Tudorel Ciurea (Romania)
13:00-15:00	Lunch
13:30 -14:30	General Electric Lunch Symposium Multi-parametric Ultrasound in the management of patients with Liver disease: from CLD to FLLs, from diagnostics to interventional procedures Moderator: Alina Popescu (Timisoara, Romania) Topic 1: Chronic Liver Disease with focus on NAFLD: a "point of care" diagnosis - Ioan Sporea (Timisoara, Romania) Topic 2: US/CEUS in the management of Focal Liver Lesions - Ákos Járay (Pécs, Hungary) Topic 3: Multi-parametric ultrasound along the Liver care pathway, from diagnostic to interventional procedures - Carla Serra (Bologna, Italy)
15:00-17:00	SRUMB - 25 years Chairmen: Ioan Sporea, Alina Popescu
15:00-15:35	SRUMB Invited Lecture "Gheorghe Badea" Lecture - The journey of vascular ultrasound Sorin Dudea (Romania)
15:35-16:10	SRUMB Invited Lecture "Gheorghe Jovin" Lecture - Point of care Ultrasound in general practice Viorela Enăchescu (Romania)
16:10-16:40	25 years of SRUMB Petru Adrian Mircea (Romania)

17:00-18:00 SRUMB General Assembly

19:30-23:30 Get together party
Fratelli By The River
1, Corneliu Coposu Blvd

Room 2 - Alfa 2

09:00-11:00 S25. Young Investigators Award - EFSUMB

Chairs:

Chairmen: Matthias Wüstner, Zeno Spârchez

09:00-09:10 The effect of incidental findings in cross-sectional imaging on an ultrasound department
Siobhan Alsop (UK)

09:10-09:20 Ultrasound-Guided Attenuation Parameter Correlates Significantly with Nas Grade and Histological Steatosis in Patients with Non-Alcoholic Steatohepatitis
Paolo Magnano San Lio (Italy)

09:20-09:30 The use of contrast-enhanced ultrasound (CEUS) and machine learning analysis in diagnosing delayed graft function in renal transplantation-a pilot study
Tudor Moisoiu (Romania)

09:30-09:40 Shear wave elastography of complex rectal polyps and early rectal cancer
Martina Kastrup Loft (Denmark)

09:40-09:50 Quantitative ultrasound imaging of uterine peristalsis for prediction of successful fertilization
Yizhou Huang (The Netherlands)

09:50-10:00 Deep vein thrombosis in COVID-19 convalescents – preliminary study
Maryla Kuczyńska (Poland)

10:00-11:00 Discussions

11:00-11:30 Coffee Break

11:30-13:00	S32. WFUMB Young Investigator Session Chairmen: Leandro Fernandez, Christian Pallson Nolsøe
11:30-11:42	Ultrasound Guided Microwave Ablation and Transarterial Chemoembolization for Unresectable Solitary-Nodule Hepatocellular Carcinoma – a Head-to-Head Survival Comparison Rareş Crăciun (EFSUMB)
11:42-11:54	Lung ultrasound of the dependent lung detects real-time changes in total lung volume in a preterm lamb model Arun Sett (ASUM)
11:54-12:06	Discordance between Breast Imaging and Histopathology Findings after Ultrasound Guided Core Needle Biopsy at Akuhn Margaret Mawania (MASU)
12:06-12:18	Quantitative ultrasound evaluation of hepatic steatosis and fibrosis in children based on backscattered statistics Chiao-San Hsieh (AFSUMB)
12:18 - 12:30	2D Shear Wave Elastography Increases the Diagnostic Accuracy of ACR-TIRADS and ATA Guideline in Thyroid Nodule Selection: Cyto and Histological Correlation Pedro Henrique de Marqui Moraes (FLAUS)
12:30-13:00	Discussions
13:30-14:30	Lunch
15:00-17:00	Mindray Lunch Symposium The Art of innovation Using advanced technologies for difficult diagnosis - Dan Stănescu (Romania) Superficial Imaging - where we are now - Vito Cantisani (Italy) Advanced applications in liver and gastrointestinal imaging - Christoph F. Dietrich (Germany)
15:00-15:20	S38. CEUS - nonliver applications Chairmen: Vito Cantisani, Brian Fowlkes
15:20-15:40	CEUS vs CT/MRI of pancreatic solid neoplasms Mirko D'Onofrio (Italy)

15:40-16:00	CEUS of Splenic lesions Paul Sidhu (UK)
16:00-16:20	CEUS in IBD Giovanni Maconi (Italy)
16:20-16:40	Intracavitary application of ultrasound contrast agents – extrabiliary indications André Ignee (Germany)
16:40-17:00	Bosniak cyst: which role for CEUS Vito Cantisani (Italy)
19:30-23:30	CEUS of the Urinary Tract: Future Diagnostic Potential Brian Fowlkes (USA)
19:30-23:30	Get together party Fratelli By The River 1, Corneliu Coposu Blvd

Room 3 - Alfa 3

09:00-11:00	S26. CEUS Chairmen: Cristina Chammas, Ákos Járay
09:00-09:20	Contrast agents for ultrasound: principles Peter Burns (Canada)
09:20-09:40	Atypical focal liver lesions on contrast-enhanced ultrasound (how to deal with lesions that hasn't read the textbook) Ákos Járay, Bálint Botz (Hungary)
09:40-10:00	CEUS dose reduction and possible advantages Fabrizio Calliada (Italy)
10:00-10:20	CEUS liver guidelines: update 2020 Cristina Chammas (Brazil)
10:20-10:40	AFSUMB Guidelines of CEUS Using Sonazoid. Won Jae Lee (South Korea)

10:40-10:50	OP 13. Liver lesion segmentation in contrast-enhanced ultrasound using deep learning algorithms Madalin Mamuleanu, Mircea Serbanescu, Cristiana Marinela Urhut, Daniela Larisa Sandulescu, Mihaela Ionescu, Costin Teodor Streba (Romania)
10:50-11:00	OP 14. Diagnostic accuracy of contrast enhanced ultrasound (CEUS) in hepatocellular carcinoma by using LI- RADS V2017 and ancillary features Adriana Ciocalteu, Ion Rogoveanu, Sevastita Iordache, Sergiu Cazacu, Cristiana Urhut, Larisa Sandulescu (Romania)
11:00-11:30	Coffee Break
11:30-13:00	S33. Joint Safety Session: WFUMB-ECMUS Chairmen: Christian Kollmann, Brian Fowlkes
11:30-11:48	The Safety of Medical Ultrasound - an overview by the ECMUS Safety Committee Carmel Moran (UK)
11:48-12:06	Development of International Standards for Ultrasonic shear wave elastography equipment Klaus V Jenderka (Germany)
12:06-12:24	Current Issues in Medical Ultrasound Safety Brian Fowlkes (USA)
12:24-12:42	Bioeffects of rabbit tissue exposed to acoustic radiation force impulses Iwaki Akiyama (Japan)
12:42-13:00	Interactive Safety Quiz for Users Christian Kollmann (Austria)
13:00-15:00	Lunch
15:00-17:00	S39. New Trends in US (AI, Innovations) Chairmen: Christoph F. Dietrich, Martin Krix
15:00-15:20	“Democratisation” of Ultrasound by Handheld Ultrasound Systems – opportunities and challenges Christian Jensen (Germany)

15:20-15:40	How to conduct good clinical ultrasound trials Martin Krix (Germany)
15:40-16:00	Dynamic contrast enhanced ultrasound, what should we know? Christoph F. Dietrich (Germany)
16:00-16:20	AI captures ultrasound - actual developments Christian Kollmann (Austria)
16:20-16:40	Artificial Intelligence Challenges in Liver Ultrasound Cătălina Mihai (Romania)
16:40-17:00	Proton therapy: dosimetry with sensitive ultrasound contrast agents and nanodroplets Nico de Jong (The Netherlands)
19:30-23:30	Get together party Fratelli By The River 1, Corneliu Coposu Blvd

Room 4 - Atena

09:00-11:00	S27. US of the thorax Chairmen: Helmut Prosch, Milan Kocián
09:00-09:25	US of the pleura Helmut Prosch (Austria)
09:25-09:45	Ultrasound of lungs Kanu Bala (Bangladesh)
09:45-10:10	Transparietal ultrasound bronchology – what can we see and what does it mean? Milan Kocián (Czech Republic)
10:10-10:35	Can COVID-19 patient ultrasound assessment benefit from Artificial Intelligence application? Michael Blaivas (USA)
10:35-11:00	Chest sonography in pneumonia and pulmonary embolism Gebhard Mathis (Austria)

11:00-11:30	Coffee Break
11:30-13:00	S34. US techniques in PHT Chairmen: Bogdan Procopeț, Ivica Grgurevic
11:30-11:48	Non cirrhotic portal hipertension - ultrasound-based diagnostic methods Bogdan Procopeț (Romania)
11:48-12:06	Ultrasound surveillance post TIPS placement Horia Ștefănescu (Romania)
12:06-12:24	Elastography differential diagnosis of portal hypertension Matteo Rosselli (Italy)
12:24-12:42	Use of Doppler in portal hypertension Ivica Grgurevic (Croatia)
12:42-13:00	Baveno VII: What changes in elastography? Antonio Carlos Matteoni de Athayde (Brazil)
13:00-15:00	Lunch
15:00-17:00	S40. Thyroid US Chairmen: Cristina Chammas, Elene Gotsiridze
15:00-15:20	Pattern recognition approach to diffuse thyroid diseases Mustafa Seçil (Turkey)
15:20-15:40	US criteria for risk of thyroid nodules: TI-RADS and guidelines Cristina Chammas (Brazil)
15:40-16:00	The role of elastography in intermediate (Bethesda III + IV) nodules Dana Stoian (Romania)
16:00-16:20	Ultrasound evaluation of thyroid lesions: misdiagnosis or overtreatment? Elene Gotsiridze (Georgia)
16:20-16:40	Post-operative thyroid US evaluation Cristina Chammas (Brazil)

16:40-16:50 OP22. Establishment and comparison of piecewise linear regression models to measure thyroid volume by 2D and 3D ultrasound
Yue Gui Wang, Hao Lin Shen, Shu Ping Yang, Ming Yong Cai, Ke Yue Chen, Ting Ting Li (China)

16:50-17:00 OP23. The value of the nomogram model based on ACR TI-RADS: prediction of the central cervical lymph node metastasis in thyroid papillary carcinoma
Keyue Chen, Xiaomei Cheng, Haolin Shen, Shuping Yang (China)

19:30-23:30 Get together party
Fratelli By The River
1, Corneliu Coposu Blvd

Room 5 - Viena

09:00-11:00 S28. Imaging techniques in HCC
Chairmen: Stephanie Wilson, Fabio Piscaglia

09:00-09:20 Liver biopsy for focal liver lesions at risk for HCC in 2021: a remainder of the past or a mandatory step?
Fabio Piscaglia (Italy)

09:20-09:40 Progress in Imaging Diagnosis of Hepatocellular Carcinoma
Won Jae Lee (South Korea)

09:40-10:00 Is it worth performing elastography in hepatocellular carcinoma?
Horia Ștefănescu (Romania)

10:00-10:20 Fusion imaging for liver ablation
Mirko D'Onofrio (Italy)

10:20-10:40 CEUS LI-RADS for Treatment Response Evaluation, proposal from the ACR LI-RADS working group
Andrej Lyshchik (USA)

10:40-11:00 Portal Venous Phase Discordance Between CEUS and MRI: A Valuable Predictor of Intrahepatic Cholangiocarcinoma
Stephanie Wilson (Canada)

11:00-11:30	Coffee Break
11:30-13:00	S35. Abdomen interventional US Chairmen: Liat Appelbaum, Cem Yucel
11:30-11:48	CEUS in ultrasound-guided interventions Christian Jenssen (Germany)
11:48-12:06	US guided interventions in biliary diseases Zeno Spârchez (Romania)
12:06-12:24	Pancreatic ablation and IRE Mirko D'Onofrio (Italy)
12:24-12:42	Interventional Ultrasound- Percutaneous Splenic biopsies Liat Appelbaum (Israel)
12:42-13:00	Ultrasound guided ablation of small renal tumors Cem Yucel (Turkey)
13:00 -15:00	Lunch
15:00-17:00	S41. POCUS in nefro-urology Chairmen: Jan Tuma, Flaviu Bob
15:00-15:20	Ultrasound in diffuse kidney disease Jan Tuma (Switzerland)
15:20-15:40	The use of contrast enhanced ultrasound in unclear renal lesions by using the Bosniak classification Dirk André Clevert (Germany)
15:40-16:00	New US techniques for the assessment of transplant kidney Flaviu Bob (Romania)
16:00-16:20	Venous thrombosis in nephrotic syndrome: an unsuspected culprit Mirela Gliga (Romania)
16:20-16:40	CEUS in penian disease Zeno Spârchez (Romania)
16:40-17:00	Testicular tumors Mustafa Seçil (Turkey)

19:30-23:30 Get together party
Fratelli By The River
1, Corneliu Coposu Blvd

Room 6 - Roma 1

09:00-11:00 S29. US Therapies and More
Chairmen: Iwaki Akiyama, Carmel Moran

09:00-09:25 Ultrasonic tissue characterization by sound velocity change due to ultrasonic heating
Iwaki Akiyama (Japan)

09:25-09:45 Ultrasound guided regenerative medicine procedures
Yusef Sayeed (USA)

09:45-10:10 Characterisation and optimisation of ultrasonic contrast agents for preclinical imaging
Carmel Moran (UK)

10:10-10:30 Therapy ultrasound + radiotherapy – why use this combination in cancer therapy
Gail ter Haar (UK)

10:30-10:55 Liver stiffness and genetic modulation
Sebastian Müller (Germany)

11:00-11:30 Coffee Break

11:30-13:00 S36. Neonatal and Pediatric US
Chairmen: Polina Pavičević, Gÿorgy Harmat

11:30-11:50 Neonatal and infant screening
Gÿorgy Harmat (Hungary)

11:50-12:10 Pocus ultrasound in pediatric patients with suspected intracranial hypertension
Blerina Saraci Qirinxhi (Albania)

12:10-12:25 Infant hip sonography: diagnostic errors
Elene Gotsiridze (Georgia)

12:25-12:40	Ultrasound imaging in neonates with suspected occult spinal dysraphism (OSD) Polina Pavićević (Serbia)
12:40-12:50	OP19. Identifiable cardiometabolic risk factors can predict subclinical atherosclerosis progression in obese children when correlated to carotid intima-media thickness measurement Monica Simina Mihuta, Corina Paul, Ioana Mozos, Dana Stoian (Romania)
12:50-13:00	OP 20. Shear Wave Elastography - a useful tool in diagnosing chronic autoimmune thyroiditis in children Cristina Mihaela Cepeha, Andreea Borlea, Corina Paul, Dana Stoian (Romania)
13:00-15:00	Lunch
15:00-17:00	S42. Joint ESNCH /EFSUMB Session (European Society for Neurosonology and Cerebral Hemodynamics) Chairmen: Eva Bartels, Zsolt Garami
15:00-15:20	Transcranial insonation protocol: Intracranial stenosis/ occlusion Eva Bartels (Germany)
15:20-15:40	Transcranial brain sonography: Established indications in neurology Uwe Walter (Germany)
15:40-16:00	Transorbital ultrasound: A useful tool in neurology Fabienne Perren (Switzerland)
16:00-16:20	The role of transcranial ultrasound in risk stratification and treatment decisions of carotid stenosis Milija Mijajlovic (Serbia)
16:20-16:40	The role of ultrasound in neurorehabilitation Adina Stan (Romania)
16:40-17:00	Robotic TCD Zsolt Garami (USA)
19:30-23:30	Get together party Fratelli By The River 1, Corneliu Coposu Blvd

Room 7 – Roma 2

09:00-11:00	S30. Prostate MPUS Chairmen: Francesco Maria Drudi, Dirk André Clevert
09:00-09:25	The advantage of prostate image fusion in daily setting Dirk André Clevert (Germany)
09:25-09:50	TRUS and Elastography for diagnosing Prostatic Cancer and performing guided Biopsies Pavlos Zoumpoulis (Greece)
09:50-10:15	Cross sectional imaging in Prostate cancer Francesco Maria Drudi (Italy)
10:15-10:40	Trans-rectal ultrasound-guided intra-prostatic injection therapy for treatment of chronic prostatitis Michael Kawooya (Uganda)
10:40-10:50	OP 15. Prediction of prostate biopsy outcome by multiparametric ultrasound imaging Massimo Mischi, Peiran Chen, Simona Turco, Wim Zwart, Pintong Huang, Hessel Wijkstra (The Netherlands)
10:50-11:00	OP 16. Ultrasound guided transperineal vs. transrectal prostate biopsy: a comparison of significant cancer detection rate Andrei Panus, Mihai Cristian Hodorog, Tudor-Cristian-Timotei Popescu, George Mitroi, Andrei Ioan Drocaț, Petru Octavian Dragoescu (Romania)
11:00-11:30	Coffee Break
11:30-13:00	S37. EUS Chairmen: Roald Flesland Havre, Andrada Seicean
11:30-11:50	EUS guided gastroenterostomy with lumen apposing metal stent in gastric outflow obstruction Roald Flesland Havre (Norway)
11:50-12:10	EUS guided Radio Frequency Ablation in pancreatic insulinomas – a single centre case series Roald Flesland Havre (Norway)
12:10-12:30	Contrast enhanced EUS Andrada Seicean (Romania)

May 25-28, 2022
Timisoara, Romania

wfumb2022.com

12:30-12:50	EUS FNA of the unusual lesions Romeo Chira (Romania)
12:50-13:00	OP 21. Quantitative assessment of Contrast Enhanced Endoscopic Ultrasonography (CE-EUS) washout rate in predicting malignancy in pancreatic solid masses: a pilot study Voicu Rednic (Romania)
13:00-15:00	Lunch
15:00-17:00	S43. US in Gynecology Chairmen: Claudiu Mărginean, Sergiu Puiu
15:00-15:20	The basics of a Gynecological U.S. Ramon Bataglia (Paraguay)
15:20-15:40	How and why transvaginal Ultrasound should be the prerequisite imaging technique in the management of bowel endometriosis George Condous (Australia)
15:40-16:00	3D in Ob/Gyn-time for routine use? Jacques Abramowicz (USA)
16:00-16:20	Ultrasound diagnosis of posterior pelvic floor disorders in women with obstructed defecation syndrome Sergiu Puiu (Moldova)
16:20-16:40	Assessment of adnexal masses using ultrasound Nihal Al-Riyami (Oman)
16:40-17:00	Adenomyosis- a challenge of ultrasound diagnosis Claudiu Mărginean (Romania)
19:30-23:30	Get together party Fratelli By The River 1, Corneliu Coposu Blvd
Room 8 - Oslo	
15:00-17:00	Hands-On Samsung

28th of May

Room 1 - Alfa 1

09:00-11:00	S44. Abdominal Emergencies Chairmen: Adela Golea, Bao Quan Nguyen Phuoc
09:00-09:25	Ultrasound integrated in clinical exam on emergency practice. Advantages and risk Adela Golea (Romania)
09:25-09:45	Usefulness of ultrasound in the unstable patient Jorge Rabat Salgh (Venezuela)
09:45-10:10	Small bowel obstruction: The value of Diagnosing Ultrasound Bao Quan Nguyen Phuoc (Vietnam)
10:10-10:35	The role of Ultrasound in acute appendicitis Călin Moș (Romania)
10:35-10:50	Usefulness of contrast-enhanced US in the diagnosis of acute cholecystitis Mirela Dănilă (Romania)
11:00-11:30	Coffee Break
11:30-13:30	S51. EFSUMB GIUS Guidelines - EFSUMB Recommendations and Guidelines for Gastrointestinal Ultrasound Chairmen: Ioan Sporea, Matthias Wüstner
11:30-11:50	Examination Techniques and Normal Findings Kim Nylund (Norway)
11:50-12:10	Acute Appendicitis and Diverticulitis Matthias Wüstner (Germany)
12:10-12:30	GIUS Intestinal Emergencies Odd Helge Gilja (Norway)
12:30-12:50	Inflammatory Bowel Diseases Ioan Sporea (Romania)

12:50-13:10	Gastrointestinal Ultrasound in Functional Disorders of the Gastrointestinal Tract Giovanni Maconi (Italy)
13:10-13:30	Endorectal, Endoanal and Perineal Ultrasound Adrian Săftoiu (Romania)
13:30-14:00	Closing Ceremony

Room 2 - Alfa 2

09:00-11:00	S45. 50 YEARS EFSUMB 1972-2022 Chairmen: Christian Jenssen, Alina Popescu
09:00-09:20	A short Introduction into the History of Ultrasound Christoph F. Dietrich (Germany)
09:20-09:40	50 years of EFSUMB - The history of the European Ultrasound Family Christian Jenssen (Germany)
09:40-09:50	Highlights and Nightmares - Memorabilia of a former EFSUMB and WFUMB President Christian Pallson Nolsøe (Denmark)
10:00-10:15	Romanian Society of Ultrasound in Medicine and Biology: 25th anniversary Petru Adrian Mircea (Romania)
10:15-10:35	The way of Ultrasound into the Premier League of Imaging - Milestones Paul Sidhu (UK)
10:35-10:50	The German Ultrasound Museum – keeping history alive Dieter Nürnberg (Germany)
10:50-11:00	The Anniversary Quiz – which answers were correct and why? Price Award Ceremony Christian Jenssen, Lynne Rudd (Germany)
11:00-11:30	Coffee Break

11:30-13:30	S52. Imaging in Fatty liver Chairmen: Giovanna Ferraioli, Ivica Grgurevic
11:30-11:50	Liver biopsy for fatty liver evaluation - an obsolete technique? Simona Bota (Austria)
11:50-12.10	Ultrasound-based techniques for quantifying liver steatosis Giovanna Ferraioli (Italy)
12:10-12:30	Cross sectional imaging for fatty liver evaluation (PDFF, Multi scan) Ioana Gheonea (Romania)
12.30-12:50	Liver steatosis and fibrosis in patients with diabetes Ivica Grgurevic (Croatia)
12.50-13:10	Ultrasound: the best method for screening in MAFLD patients Ioan Sporea (Romania)
13:10-13:20	OP 26. Population ultrasound (pop-us) by the attenuation coefficient measurement for screening non-alcoholic fatty liver disease Oleh Dynnyk, Natalia Marunchyn, Svetlana Zakrevska, Iryna Oraevska, Lilia Kovalerenko, Maksym Zhaivoronok (Ukraine)
13:20-13:30	OP 27. Steatosis and fibrosis predictive scores in patients with type 2 diabetes Ruxandra-Georgeta Mare, Raluca Lupusoru, Ioan Sporea, Alina Popescu, Alexandra Sima, Romulus Timar, Roxana Şirli (Romania)

Room 3 - Alfa 3

09:00-11:00	S46. New US techniques in pediatrics (CEUS, Elasto) WFPI (World Federation of Pediatric Imaging) session Chairmen: Joanna Kasznia-Brown, Andres Garcia Bayce
09:00-09:18	Emergency ultrasound imaging in paediatric intensive care Joanna Kasznia-Brown (UK)
09:18-09:36	Importance of cerebral ultrasound for evaluation and monitoring of neonates undergoing surgery Oana Stanciu (Romania)

May 25-28, 2022
Timisoara, Romania

wfumb2022.com

09:36-09:54	Catheter related complications in the Neonatal Intensive Care Andres Garcia Bayce (Uruguay)
09:54-10:12	Chest ultrasound in paediatric imaging Jovan Lovrenski (Serbia)
10:12-10:30	Imaging of small bowel in children Joanna Kasznia-Brown (UK)
10:30-10:48	Pre and post surgical ultrasound aspects in pediatric testicular torsion Cristina-Mihaela Popescu (Romania)
10:48-11:00	Contrast ultrasound in paediatric imaging – do we do enough? Panel discussion
11:00-11:30	Coffee Break
11:30-13:30	S53. Obstetrics and fetal malformations Chairmen: Daniela Chiriac, Jacques Abramowicz
11:30-11:50	Ultrasound assessment of the fetal heart Panos Ansaklis (Greece)
11:50-12:10	Growth assessment Alexandros Sotiriadis (Greece)
12:10-12:30	Fetal gastro-Intestinal and Abdominal Wall defects Daniela Chiriac (Romania)
12:30-12:50	Ultrasound of the fetal eyes Jacques Abramowicz (USA)
12:50-13:00	OP 28. Transabdominal ultrasound combined with transvaginal ultrasound screening for fetal cardiac abnormalities in early pregnancy Ruibi Liao, Guorong Lyu (China)
13:00-13:10	OP 29. Ultrasound assessment of fetal structural abnormalities at nuchal scan Ciprian Patru, Stefania Tudorache, Razvan Capitanescu, Cristian Marinas, Marina Dinu, Nicolae Cernea (Romania)
13.10-13:20	OP 30. First trimester fetal heart interpretation by artificial intelligence Dominic Iliescu, Ciprian Patru, Rodica Nagy, Dan Ruican (Romania)

13:20-13:30 OP 31. Value of uterine notching assessment as an independent factor in predicting preeclampsia-a cross sectional study
Andreea Denisa Hodorog, Marina Dinu, Mihai Cristian Hodorog, Stăncioi-Cismaru Andreea Florentina, Elinor Dumitru Luciu, Stefania Tudorache (Romania)

Room 4 - Atena

09:00-11:00 S47. INVUS
Chairmen: Romeo Chira, Ciprian Brisc

09:00-09:20 Liver biopsy today
Ciprian Brisc (Romania)

09:20-09:40 HPB ultrasound guided interventional procedures
Mirko D'Onofrio (Italy)

09:40-10:00 Ultrasound guided peripheral nerve stimulation
Yusef Sayeed (USA)

10:00-10:20 Ultrasound guided stellate blocks for post traumatic stress disorder
Yusef Sayeed (USA)

10:20-10:40 Atypical percutaneous US guided biopsies - what are the possibilities and the limits?
Romeo Chira (Romania)

10:40-10:50 OP 24. Microwave ablation versus laparoscopic resection as first-line therapy for solitary 3-5 cm hepatocellular carcinoma
Wang Zhen, Yu Jie, Liang Ping (China)

10:50-11:00 OP 25. Period-dependent survival benefit of percutaneous microwave ablation for hepatocellular carcinoma: a 12-year real-world, multicentric experience
Jie Yu (China)

11:00-11:30 Coffee Break

11:30-13:30 S54. EUS
Chairmen: Adrian Săftoiu, Romeo Chira

11:30-11:55	Endoscopic ultrasound as one-stop shop for pancreatic cancer Adrian Săftoiu (Romania)
11:55-12:20	EUS guided pancreatic collection drainage Andrada Seicean (Romania)
12:20-12:45	EUS for Neuroendocrine Tumors Mariana Jinga, Daniel Vasile Balaban (Romania)
12:45-13:05	Role of Endoscopic Ultrasound in diagnosing and staging of ampullary tumors Bogdan Miutescu (Romania)
13:05-13:30	EUS FNA of the vertebral body osteolytic lesions - a new diagnostic approach Romeo Chira (Romania)

Room 5 - Viena

09:00-11:00	S48. Renal US Chairmen: Richard Barr, Liat Appelbaum
09:00-09:20	Cystic Kidney Diseases Adnan Kabaalioğlu (Turkey)
09:20-09:40	CEUS of indeterminate renal masses Richard Barr (USA)
09:40-10:00	Interventional Ultrasound- Renal mass biopsies Liat Appelbaum (Israel)
10:00-10:20	Ceus in Renal Transplant reflux Francesco Maria Drudi (Italy)
10:20-10:40	Imaging diagnosis of nutcracker phenomenon and nutcracker syndrome: too little investigated and too much neglected Seung H. Kim (South Korea)
10:40-11:00	Ultrasound of urinary bladder, the neglected organ Kanu Bala (Bangladesh)

11:00-11:30	Coffee Break
11:30-13:30	S55. Vascular US Chairmen: Andrej Lyshchik, Bogdan Procopeț
11:50-12:10	Renal Doppler Diana Gaitini (Israel)
11:30-11:50	The ultrasound based approach of patients with porto-sinusoidal vascular disease Bogdan Procopeț (Romania)
12:10-12:30	Tumour Angiogenesis and CEUS Peter Burns (Canada)
12:30-12:50	CEUS for aortic endoleak detection and classification Andrej Lyshchik (USA)
12:50-13:10	Unstable plaque multimodal ultrasound characteristics Maija Radzina (Latvia)
13:10-13:20	OP 32. Arteriovenous fistula flow and cardiac heart failure in hemodialysed patients Maria Daniela Teodora, Daniel Cosmin Cargea, Alexandru Andritoiu, Kamal Constantin Kamal (Romania)
13:20-13:30	OP 33. Transcranial doppler-based model to predict neurological function after intra-arterial mechanical thrombectomy for acute anterior circulation large vessel occlusion Yufei Lin, Guorong Lv, Haolin Shen, Shuping Yang (China)

Room 6 - Roma 1

09:00-11:00	S49. Head and Neck Chairmen: Cristina Chammas, Tobias Todsen
09:00-09:20	35 years ultrasound of the salivary glands, lesions to be learned Norbert Gritzmann (Austria)
09:20-09:40	Sonography of the floor of the mouth Norbert Gritzmann (Austria)

May 25-28, 2022
Timisoara, Romania

wfumb2022.com

09:40-10:00	Evaluation of cervical lymph nodes (duplex scan and color Doppler) Cristina Chammas (Brazil)
10:00-10:20	Thyroid US Adnan Kabaalioğlu (Turkey)
10:20-10:40	Ocular ultrasound Christoph F Dietrich (Germany)
10:40-11:00	Transoral Ultrasound Tobias Todsén (Denmark)
11:00-11:30	Coffee Break
11:30-13:00	S56. POCUS in endocrinology Chairmen: Mustafa Seçil, Ivan Quiros
11:30-11:50	Thyroid US anatomy and technique Mustafa Seçil (Turkey)
11:50-12:10	Thyroid nodules: evaluation with duplex scan and color Doppler Cristina Chammas (Brazil)
12:10-12:30	Eco-guided FNA and Core Biopsy in Thyroid and Neck: Simple Methods Ivan Quiros (Peru)
12:30-12:50	Parathyroid: spectrum of US findings Mustafa Seçil (Turkey)
12:50-13:10	Ultrasound localization of parathyroid adenoma Liat Appelbaum (Israel)
13:10-13:30	US and imaging of adrenal gland: A review and an update William Yung Liang Wan (Taiwan)
Room 7 - Roma 2	
09:00-11:00	S50. Less known in US Chairmen: Hassen A. Gharbi, Bogdan Procopet
09:00-09:25	Schistosomiasis: Approach to diagnosis Amir Sultan Seid (Ethiopia)

09:25-09:50	US in hydatid cyst: history and today Hassen A. Gharbi (Tunisia)
09:50-10:15	Never Seen before and we might never see it again Christoph F Dietrich (Germany)
10:15-10:40	The ultrasound examination of Budd-Chiari syndrome Bogdan Procopeț (Romania)
10:40-11:00	Multimodal and multiparametric phantom for training in the diagnosis of liver diseases (viscosity, steatosis, fibrosis) Oleh Dynnyk (Ukraine)
11:00-11:30	Coffee Break
11:30-13:30	S57. Student's US education around the world Chairmen: Roxana Șirli, Hassen A. Gharbi
11:30-11:50	Europe Roxana Șirli (Romania)
11:50-12:10	Asia William Yung Liang Wan (Taiwan)
12:10-12:30	MASU Hassen A. Gharbi (Tunisia)
12:30-12:50	South America Cristina Chammas (Brazil)
12:50-13:10	North America Michael Blaivas (USA)

Room 8 - Oslo

09:00-12:00 **Hands-On Mindray**



E-poster session

-
- PCR01** A Typical Hepatic Hemangiomas
Kristjana Bero, Silva Kurti, Joana Kurti, Adela Florentina Baran, Silviu Mihai Deliu, Alexandrina Hagioglo
(Romania)
-
- PCR02** Role of Contrast-Enhanced Ultrasonography in the Diagnosis of Liver Metastasis in Cirrhosis Patients
Lorena Ungureanu, Camelia-Cristiana Bigea, Mihaela-Roxana Cituran, Carmen-Daniela Neagoe, Daniela-Larisa Sandulescu, Ion Rogoveanu
(Romania)
-
- PCR03** Endoscopic Ultrasound Diagnosis of Unusual Subepithelial Tumors: Case Series
Robert - Emmanuel Șerban, Victor Mihai Sacerdoțianu, Robert Cristian Godeanu, Irina Paula Doica, Bogdan Silviu Ungureanu, Tudorel Ciurea
(Romania)
-
- PCR04** The Role of Ultrasonography And Added Value of Contrast-Enhanced Ultrasonography in Diagnosis of Splenosis – A Case Report
Elena Simona Ioanitescu, Eugenia Mîndruț, Vlad Herlea, Elena Laura Iliescu
(Romania)
-
- PCR05** Multiple Retroperitoneal Metastasis Burkitt Lymphoma: A Case Report
Elena Simona Ioanitescu, Adriana Mercan Stanciu, Mugur Grasu, Elena Laura Iliescu
(Romania)
-
- PCR06** A Case of Esophagogastric Cancer: The Great Masquerader
Andreea Franculescu-Berteau, Ionel Copaci, Elena Laura Iliescu, Elena Simona Ioanitescu
(Romania)
-
- PCR07** Acute Varicocele Thrombosis After Vaccination With mRNA SARS-CoV-2 Vaccine- A Case Report
Teofana Dulgheriu, Sorin Ducea, Delia Muntean
(Romania)
-

-
- PCR08 A Case of Tricuspid, Aortic And Mitral Valves Endocarditis
Elena Lelia Croitoru, Madalina Stancescu, Mircea Penescu
(Romania)
-
- PCR09 Importance of Ultrasonography in the Diagnosis and the Management of
Pregnant Women With HELLP Syndrome
Eleonora Carpov, Corina Dascalu, Svetlana Rotaru, Andreea Blaj, Iulia
Pintilie, Corina Neacsu
(Romania)
-
- PCR11 Abscess After Thread-Lifting
Natalia Vetsheva
(Russian Federation)
-
- PCR12 The Role of Us Examination in the Diagnosis And Percutaneous Approach
of Hepatic Abscesses – A Case Report
Madalina Ilariana Prioteasa, Tudorel Ciurea, Marius Bica, Sarmis Marian
Sandulescu, Vlad Florin Iovanescu, Daniela Larisa Sandulescu
(Romania)
-
- PCR13 Different Responses to Parvovirus Infection in Twin Pregnancy: Death
Versus Healthy Fetus
Ingrid Rocha e Silva, Poliani Prizmic, Cristina Chammas
(Brazil)
-
- PCR14 Abdominal Pain and Ultrasonography in Children - Too Easy to be True?
Virginia Bodescu, Sanda Lucia Voicu, Cristina Rusu, Adriana
Gomotârceanu, Mirela Gliga, Cristian Chirilă
(Romania)
-
- PCR15 Role of Contrast-Enhanced Ultrasonography in The Diagnosis of Liver
Metastasis in Cirrhosis Patients
Lorena Ungureanu, Camelia-Cristiana Bigea, Mihaela-Roxana Cituran,
Carmen-Daniela Neagoe, Daniela-Larisa Sandulescu, Ion Rogoveanu
(Romania)
-
- PCR16 Imaging in The Initial Diagnosis of Pancreatic Insulinoma
Claudiu - Marinel Ionele, Dan-Ionut Gheonea, Cristin-Constantin Vere,
Bogdan-Silviu Ungureanu, Larisa-Daniela Sandulescu, Ion Rogoveanu
(Romania)
-

-
- PCR17** Contrast-Enhanced Ultrasound in the Diagnosis of Renal Cell Carcinoma
Camelia - Cristiana Bigea, Maria-Lorena Ungureanu, Mihaela-Roxana Cituran, Ion Rogoveanu, Carmen-Daniela Neagoe, Larisa-Daniela Sandulescu
(Romania)
-
- PCR18** Postprandial Hypoglycemia in a Pancreatic Insulinoma: A Case Report
Irina Doica, Robert Godeanu, Robert Serban, Tudorel Ciurea, Alexandru Munteanu, Bogdan Ungureanu
(Romania)
-
- PCR19** Ultrasonographic Clues in Pappilary Necrosis
Gliga Mirela, Adriana Gomotirceanu, Virginia Bodescu, Mihai Gliga, Paula Chirila, Cristian Chirila
(Romania)
-
- PCR20** Subcapsular Renal Hematoma
Elena Lelia Croitoru, Constantin Verzan, Mihai Dumitrache, Mircea Penescu
(Romania)
-
- PCR21** The Role of Ceus in the Diagnosis of a Rare Case of Hcc and Spleen Metastases
Silva Kurti, Kristjana Bero, Joana Kurti, Madalina Elena Mandache, Silviu Mihai Deliu, Manal Elshaer, Alexandrina Hagioglo
(Romania)
-
- PCR22** contrast- Enhanced Ultrasound in the Diagnosis of Hepatic Parenchymal Pseudolesions- A Case Series
Larisa Sandulescu, Adriana Ciocalteu, Sarmis Marian Sandulescu, Cristiana Eugenia Simionescu, Andreea Alexandra Rosu, Ion Rogoveanu
(Romania)
-
- PCR23** Atypical Liver Metastases- A Spectrum of Ultrasound Findings- Case Series
Cristiana Marinela Urhut, Sarmis Marian Sandulescu, Theodor Dumitrescu, Cristiana Eugenia Simionescu, Corina Mirela Ghilusi, Daniela Larisa Sandulescu
(Romania)
-
- PCR24** Differential Diagnosis of Atypically Located Appendicitis
Natalia Vetsheva, Elena Tatarkina, Dmitriy Pykhteev, Natalia Vetsheva
(Russian Federation)
-

-
- PCR25 Endogenous Endophthalmitis Secondary to Liver Abscess: A Case Report
Robert Cristian Godeanu, Victor Mihai Sacerdotianu, Robert Emmanuel Serban, Irina Paula Doica, Ion Rogoveanu, Bogdan Silviu Ungureanu (Romania)
-
- PCR26 Follow-up a Cavernous Portal Vein Transformation in a Young Patient - Ultrasonography Challenge
Adrian Boicean, Sabrina Birsan, Alexandru Birsan, Stefana Ginfalean, Teodora Baluță, Rodica Pascal (Romania)
-
- PCR27 Ascaris Lumbricodes in the Gallblader
Olga Pushkarenko, Olesya Horlenko, Inna Khalaturnyk (Ukraine)
-
- PCR28 Peritoneal Loose Bodies: Accidental Findings
Olga Pushkarenko, Stepan Bilyak, Serhiy Pushkarenko (Ukraine)
-
- PP01 The Benefit of USG in Diagnosing Radial Scars in the Context of Differential Diagnosis of Breast Lesions
Jana Slobodnikova (Slovakia)
-
- PP02 The Issue Of Upper Extremity Lymphedema in Women Following Surgery for Breast Cancer - The Accuracy of Diagnosis by Sonography, Pilot Study.
Jana Slobodnikova, Miroslav Černický (Slovakia)
-
- PP03 Diagnosis of Breast Cancer During Pregnancy and Breastfeeding
Georgiana-Cristiana Camen, Oana-Adelina Lazarescu, Teodor-Nicusor Sas, Simona Bondari, Claudiu-Marinel Ionele, Ion Rogoveanu (Romania)
-
- PP04 Value of Contrast-Enhanced Ultrasound in the Differential Diagnosis of Gallbladder Lesion
Petrică Popa, Larisa Daniela Sandulescu, Dan Ionut Gheonea, Ioana Gheonea, Sarmis Sandulescu, Cristiana Eugenia Simionescu (Romania)
-

-
- PP05** Differentiating Solid Pancreatic Lesions: The Contribution of Eus-Fnb With Contrast-Enhanced Imaging
Irina Florina Cherciu Harbiyeli, Albert Georgescu, Fadel Georges, Alexandra Adriana Fieraru, Elena Daniela Burtea, Adrian Săftoiu (Romania)
-
- PP06** How to Improve the Contrast Enhanced Ultrasound (Ceus) Li-Rads Algorithm for the Diagnosis of Definite Hepatocellular Carcinoma: The Role Of Combination Of Lr- 4 And Lr-5
Larisa Sandulescu, Adriana Ciocalteu, Sarmis Sandulescu, Ana- Maria Ciurea, Adrian Săftoiu, Ion Rogoveanu (Romania)
-
- PP07** Evaluation of Liver Tumors by Using Artificial Intelligence in Contrast-Enhanced Ultrasound
Cristiana Marinela Urhut, Costin Theodor Streaba, Ion Rogoveanu, Madalin Mamuleanu, Suzana Danoiu, Daniela Larisa Sandulescu (Romania)
-
- PP08** One Stop Shop Approach for The Diagnosis of Liver Hemangioma
Madalina Ilariana Prioteasa, Ion Rogoveanu, Adriana Ionescu Ciocalteu, Cristiana Marinela Urhut, Vlad Florin Iovanescu, Daniela Larisa Sandulescu (Romania)
-
- PP09** The Usefulness of Ceus In The Evaluation of Hepatic Hemangioma – Retrospective Study
Domenco Aurelia-Stefania, Adriana Ionescu-Ciocalteu, Sarmis Marian Sandulescu, Cristiana Urhut, Larisa Daniela Sandulescu (Romania)
-
- PP10** The Role of Contrast-Enhanced Ultrasound in Focal Fatty Lesions Characterisations in Nafld and Mafld Patients
Mihai Cătălina, Mihaela Dranga, Otilia Gavrilescu, Cristina Cijevschi Prelipcean (Romania)
-
- PP11** Renal Shear Wave Elastography in Chronic Urinary Infections
Elena Dana Nedelcu, Petrica Denisa, Mihaela Morega (Romania)
-

-
- PP12 Quantitative Ultrasound Methods for the Assessment of Liver Steatosis Using Controlled Attenuation Parameter as Reference Method
Alina Popescu, Camelia Foncea, Raluca Lupusoru, Radu Cotrau, Felix Bende, Roxana Şirli, Ioan Sporea (Romania)
-
- PP13 Elastographic Differences Encountered in Children And Adults Diagnosed with Chronic Autoimmune Thyroiditis
Cristina Mihaela Cepeha, Andreea Borlea, Corina Paul, Dana Stoian (Romania)
-
- PP14 Diagnostic Performance of Transient Elastography in Chronic Hepatitis C Patients: a Single-Center Large-Cohort Study
Alexandra Iulia Silion, Teodora Serban, Monica Platon-Lupşor (Romania)
-
- PP15 Is Quantitative Elastography Using 2d-Shear Wave Ultrasonography a Feasible Method for Assessing Renal Grafts?
Felix - Mihai Maralescu, Flaviu Bob, Alina Popescu, Roxana Şirli, Adalbert Schiller, Ligia Petrica (Romania)
-
- PP16 Point-Shear Wave Elastography in the Evaluation of Stable Ckd Diabetic Patients
Cristian Chirila, Paula Maria Chirila, Adriana Gomotirceanu, Mihail Gliga, Mirela Liana Gliga (Romania)
-
- PP17 Elastography and Thyroid Nodules: Strain Versus 2d Shear-Wave Elastography Parameters
Andreea Borlea, Ioan Sporea, Melania Balas, Alexandru Popa, Dana Stoian (Romania)
-
- PP18 How Many Auto Pswe And Ultrasound Derived Fat Fraction (Udff) Acquisitions Should We Make in Order to Obtain the Best Result?
Lupusoru Raluca, Alina Popescu, Ioan Sporea, Radu Cotrau, Felix Bende, Foncea Camelia, Roxana Şirli (Romania)
-

-
- PP19 Chronic Kidney Disease in Patients With Nonalcoholic Fatty Liver Disease
Doina Georgescu, Oana-Elena Ancusa, Ioana Suceana, Norina Basa, Mihai Ionita, Daniel-Florin Lighezan
(Romania)
-
- PP20 Application of Artificial Intelligence for Pre-Screening Prostate Cancer Using Shear Wave Elastography Measurements
Cosmin-Ciprian Secășan, Darian Onchis, Razvan Bardan, Ioan Sporea
(Romania)
-
- PP21 Comparison of Ultrasound Elastography Values Between: Different Machines, Transducers, Acquisition Depths, Roi Diameters And Examiners, on a Biological Tissue in Vitro Study - Preliminary Results.
Teofana Dulgheriu, Delia Muntean, Carolina Solomon, Sorin Dudea
(Romania)
-
- PP22 Shear Wave Elastography – Differences Between Primary and Secondary Hyperparathyroidism
Laura Cotoi, Dana Amzar, Andreea Borlea, Ioan Sporea, Dana Stoian
(Romania)
-
- PP23 Thyroid Pathology in End-Stage Renal Disease Patients on Hemodialysis
Laura Cotoi, Dana Amzar, Ioan Sporea, Andreea Borlea, Oana Schiller, Dana Stoian
(Romania)
-
- PP24 The Clinical Setting of Shear Wave Elastography in Secondary Hyperparathyroidism
Laura Cotoi, Dana Amzar, Ioan Sporea, Andreea Borlea, Oana Schiller, Nicusor Pop, Dana Stoian
(Romania)
-
- PP25 Diagnostic Performance of Spleen Stiffness Measurements With Two-Dimensional Shear-Wave Elastography by Supersonic Imagine for Esophageal Varices In Patients With Compensated Advanced Chronic Liver Disease
Anita Madir, Marko Lucijanac, Darko Brnic, Marko Zelenika, Mislav Barisic Jaman, Ivica Grgurevic
(Croatia)
-

-
- PP26 Performance of a p-SWE implemented on a New Ultrasound System for Predicting Advanced Liver Fibrosis
Alexandru Popa, Ioan Sporea, Roxana Şirli, Alina Popescu, Felix Bende, Camelia Foncea, Raluca Lupusoru, Victor Baldea, Radu Cotrau, Ariana Pascu, Andreea Borlea, Renata Fofiu (Romania)
-
- PP27 Comparison Between Two 2d-Swe Techniques Using Transient Elastography as a Reference Method for Liver Stiffness Assessment
Alina Popescu, Camelia Foncea, Radu Cotrau, Raluca Lupusoru, Roxana Şirli, Ioan Sporea (Romania)
-
- PP28 Liver Elasticity in Healthy Individuals Using P-Swe And 2dswe Implemented on Two New Ultrasound Systems Using Transient Elastography as the Reference Method
Pascu Anca Ariana, Alina Popescu, Felix Bende, Roxana Şirli, Camelia Foncea, Radu Cotrau, Victor Baldea, Andrei-Dorel Plopeanu, Alexandru Popa (Romania)
-
- PP29 Point Shearwave Elastography Techniques for the Assessment of Liver Stiffness
Alina Popescu, Camelia Foncea, Raluca Lupusoru, Radu Cotrau, Felix Bende, Roxana Şirli, Ioan Sporea (Romania)
-
- PP30 Performance of a 2d-Swe For The Diagnosis of Liver Fibrosis Using Transient Elastography as Reference Method
Foncea Camelia, Alina Popescu, Raluca Lupusoru, Radu Cotrau, Felix Bende, Tudor Moga, Roxana Şirli, Ioan Sporea (Romania)
-
- PP31 Noninvasive Biological Fibrosis Scores, Useful Tools for Evaluating Nafld Patients
Radu Cotrau, Alina Popescu, Ioan Sporea, Raluca Lupusoru, Camelia Foncea, Felix Bende, Roxana Şirli (Romania)
-

-
- PP32** Liver Fibrosis and Steatosis Assessment Using Elastographic Techniques: a Comparison Between Nonalcoholic Fatty Liver Disease and Alcoholic Liver Disease
Camelia Foncea, Ioan Sporea, Raluca Lupusoru, Radu Cotrau, Felix Bende, Roxana Şirli, Alina Popescu (Romania)
-
- PP33** Comparison of Eus Parameters in Patients With Esophageal Varices on Primary And Secondary Prophylaxis on Combination Therapy
Todor Angelov, Stanislav Churchev, Borislav Vladimirov, Branimir Golemanov (Bulgaria)
-
- PP34** The Role of Intestinal Ultrasound in Monitoring Patients with Inflammatory Bowel Disease
Sevastita Iordache, Razvan-Cristian Statie, Dan-Nicolae Florescu, Bogdan-Silviu Ungureanu, Vlad Iovanescu, Tudorel Ciurea (Romania)
-
- PP35** Success Rates of Liver Stiffness Measurements Using Point Shear-Wave Elastography And 2d Shear Wave Elastography Using Different Ultrasound Probes. Does a New Bariatric Probe Increase Liver Stiffness Measurements Success Rates in Obese?
Felix Bende, Roxana Şirli, Alina Popescu, Ariana Pascu, Alexandru Popa, Camelia Foncea, Victor Baldea, Radu Cotrau, Raluca Lupusoru, Ioan Sporea (Romania)
-
- PP36** A National Register for Interventional Ultrasound (Invus) in Germany: Outline and Preliminary Results of a Pilot Study
Nicole Eder, Nils Daum, Dominik Antonius Seckinger, Dieter Nürnberg, Christian Jossen (Germany)
-
- PP37** Long-Term Ultrasound Follow-Up in Patients with Small Gallbladder Polyps
Malene Roland Pedersen, Peter Otto, Søren Rafaelsen (Denmark)
-
- PP38** A Hybrid Machine Learning Model Based on Semantic Information Can Optimize Treatment Decision for Naive Single 3-5cm Hcc Patients
Ping Liang, Wen-zhen Ding (China)
-

-
- PP39** Stratification of Liver Steatosis by the Attenuation Coefficient Measurement (Acm) of The Hand-Held Ultrasound Device
Oleh Dynnyk, Oleksandr Solodovnyk, Oleksandr Zakomorny, Nazarii Kobyliak (Ukraine)
-
- PP40** Ablation Combined with Systemic Treatment for Colorectal Liver Oligo-Metastases: What's The Optimal Sequencing?
Jianming Li (China)
-
- PP41** Dynamics of Portal Vein Velocity – A Potentially Useful Tool for Detecting Clinically Silent Tips Dysfunction
Rares Craciun, Andreea Fodor, Oana Nicoara-Farcau, Petra Fischer, Ingrid Iuhasz, Zeno Spârchez, Horia Ștefănescu, Bogdan Procopeț (Romania)
-
- PP42** Complex Ultrasound Examination in the Diagnosis of Early Forms of Hepatic Steatosis
Adriana Botezatu (Romania)
-
- PP43** Utilization of Sonographic Quantitative Techniques for Detection of Steatosis in Patients with Nonalcoholic Fatty Liver Disease From Northern Caucasus Region
Elisaveta Paleonaya, Nikolay Nilassov, Maxim Morgunov, Alexandr Zubov, Andrew Paleonyy, Olga Eroshenko (Ukraine)
-
- PP44** Utilizing Ultrasound Imaging for Evaluating Fatty Liver Disease in Mouse Model
Keiko Iwaisako, Hiraki Tsushima, Tomoki Matsukawa, Kei Matsumoto, Reiji Kayamoto, Shinji Takayanagi, Iwaki Akiyama (Japan)
-
- PP45** Validation of Noninvasive Algorithms for Diagnosing Esophageal Varices in Patients With Compensated Advanced Chronic Liver Disease
Frane Paštrović, Marko Lucijanić, Mislav Barišić-Jaman, Adriana Unić, Lovorka Đerek, Ivica Grgurević (Croatia)
-

-
- PP46 Endothelial Dysfunction Associated with Nonalcoholic Fatty Liver Disease in Low Cardiovascular Risk Patients
Monica Susan, Roxana Şirli, Razvan Susan, Radu Cotrău, Daniel Malița, Daniel Lighezan
(Romania)
-
- PP47 New Promising Methods of Treatment With Injections And Applying Different Fractions of Plasma IPRF and APRF in Muskuloskeletal Injuries and Arthrosis. Films From Tests And Injections of Plasma Fractions.
Tomasz Kardacz
(Poland)
-
- PP48 Ultrasonographic Characteristics of the Normal Anterolateral Ligament of the Knee Joint
Viktor Kotiuk, Oleksandr Kostrub, Roman Luchko, Lyudmila Osadcha, Roman Blonskyi, Dmitry Smirnov
(Ukraine)
-
- PP49 Prevalence of Ultrasound - Detected Plantar Fascia Abnormalities in Spondyloarthropathies By High-End Ultrasound Imaging
Marija Montvydaite, Goda Seskute, Gabija Jasionyte, Irena Butrimiene
(Lithuania)
-
- PP50 Updated Technique for Measuring Synovial Thickness And Inflammation Activity in Knee Joint By High-End Ultrasound: Pictorial Case Series
Gabija Jasionytė, Goda Seskute, Marija Montvydaite, Irena Butrimiene
(Lithuania)
-
- PP51 Imaging Methods in Assessing The Course of RA.
Olga Alekseeva, Alexander Smirnov, Alexander Volkov, Evgeniy Nasonov
(Russian Federation)
-
- PP52 Diagnosis and Prognosis of Rheumatoid Arthritis: Focus on Diagnostic Methods.
Olga Alekseeva, Alexander Smirnov, Alexander Volkov, Evgeniy Nasonov
(Russian Federation)
-
- PP53 Ultrasound Signs of Joint Inflammation in Patients With Arthralgia Induced by Hormonal Therapy of Breast Cancer
Olga Alekseeva, Anastasia Koltakova, Alexander Volkov, Alexander Lila
(Russian Federation)
-

-
- PP54 Carotid Intima Media Thickness is a Valuable Tool For the Assessment of Cardiometabolic Risk in Obese Children
Monica Simina Mihuta, Corina Paul, Ioana Mozos, Dana Stoian (Romania)
-
- PP55 Lung Ultrasound in Neonates With Covid-19 Pneumonia – The Start of a New Era
Emil - Robert Stoicescu, Daniela Iacob, Roxana Iacob, Simona Cerbu, Emil-Radu Iacob, Diana Manolescu (Romania)
-
- PP56 Semi-Quantitative Evaluation of the Hepatic and Pancreatic Steatosis by Gray Scale Echogenicity
Oleh Dynnyk, Oleksandr Fedusenko, Nazarii Kobyljak, Jeanne Makarova (Ukraine)
-
- PP57 Prediction of The Severity of Acute Pancreatitis Using Ultrasound Date
Valeriia Rudenko (Russian Federation)
-
- PP58 The Significance of Ultrasound Examination in Diagnosis of Palpable Lesions in the Neck
Katarzyna Drelich, Maryla Kuczyńska, Agnieszka Brodzisz, Magdalena Woźniak (Poland)
-
- PP59 New Technology Ultrasound Tomography by Thyroid Volume Assessment
Tomasz Kardacz (Poland)
-
- PP60 The Value of Tirads Scores in The Ultrasound Evaluation of Thyroid Nodule
Mihaela Vlad, Ioana Golu, Andreea Toma, Daniela Amzar, Melania Balas (Romania)
-
- PP61 Thyroid Surgery Indications: To What Extent is The Ultrasound Risk-Stratification of Thyroid Nodules Performed in Clinical Setting?
Andreea Borlea, Laura Cotoi, Dan Alin Brebu, Amadeus Dobrescu, Fulger Lazar, Marioara Cornianu, Dana Stoian (Romania)
-

-
- PP62 The Value of Shear-Wave Elastography in the Diagnosis And Follow-Up of Post COVID-19 Subacute Thyroiditis
Ioana Golu, Melania Balas, Daniela Amzar, Ioana Milos, Ana Corlan, Mihaela Vlad
(Romania)
-
- PP63 Thyroid Pathology in End-Stage Renal Disease Patients on Hemodialysis
Laura Cotoi, Dana Amzar, Ioan Sporea, Oana Schiller, Nicusor Pop, Dana Stoian
(Romania)
-
- PP64 Thyroid Elastography and Volumetric Doppler in the Evaluation of Bethesda III and IV Nodules
Andreea Borlea, Laura Cotoi, Dana Stoian
(Romania)
-
- PP65 A 5-Year Retrospective Study of The Introduction of High Frequency Ultrasound of the Skin in The University Clinic of Dermatology in Timișoara
Valentin - Tudor Popa, Patricia Cristodor, Caius Solovan, Bianca Natarăș, Sorin Ursoniu
(Romania)
-
- PP66 High-Frequency Ultrasonographic Analysis in the Evaluation of Therapeutic Response in Patients with Psoriasis Vulgaris
Ioana-Alina Halip, Valentin-Tudor Popa, Dan Vata, Laura Statescu, Maria Crișan, Laura Gheuca Solovăstru
(Romania)
-
- PP68 Is Biopsy of Renal Transplant Always Safe? The Role of Ultrasound Examination.
Olga Pustelniak, Maryla Kuczynska, Anna Drelich-Zbroja, Michal Sojka, Tomasz Jargiello
(Poland)
-
- PP69 Bladder Ultrasonography as First Step Noninvasive Approach in Female Patients with Irritable Bowel Syndrome and Overactive Bladder
Doina Georgescu, Izabella Petre, Adalbert Schiller, Liviu-Andrei Georgescu
(Romania)
-

-
- PP70 Localization of Solid Renal Cell Cancer by Quantitative Contrast-Enhanced Ultrasound Imaging
Peiran Chen, Simona Turco, Christiaan Widdershoven, Hessel Wijkstra, Massimo Mischi, Patricia Zondervan (Netherlands)
-
- PP71 Clear Cell Renal Cell Carcinoma: Attempt to Compare Sonographic Appearances to Tnm Staging System Of Uicc/Ajcc
Olga Pushkarenko, Stepan Bilyak, Olesya Horlenko, Inna Khalaturnyk (Ukraine)
-
- PP72 Clinical-Ultrasound-Screening of Chronic Kidney Disease(Ckd) In High-Risk Patients With Known Cardio-Renal-Metabolic Disorders and The Correlations Between Clinical Methods of Kdigo Assessment of Renal Function And Renal Multimodal Ultrasound by Family Physicians
Mihai Iacob (Romania)
-
- PP73 Rapid Detection of Nafld And Its Evolutionary Stages Toward Cirrhosis at the Targeted Population Through Multiparametric Liver Ultrasonographic Screening (Mlus) and Artificial Intelligence with Fibrosis Risk Stratification by Family Physicians.
Mihai Iacob (Romania)
-
- PP74 Ultrasound - an Excellent and Necessary Tool at a Family Doctor Practice
Tomasz Kardacz (Poland)
-
- PP75 The Diagnostics of Lower Limb Edema - Importance of Ultrasound Examination
Monika Zbroja, Maryla Kuczyńska, Małgorzata Drelich, Magdalena Woźniak (Poland)
-
- PP76 Fetal Echocardiographic Features and Clinical Significance of Different Types Left Brachiocephalic Vein Abnormalities
Ruibi Liao, Guorong Lyu (China)
-

-
- PP77 The Use of Ultrasound In The Management of Labor - Update
Roxana - Cristina Dragusin, Lucian Zorila, Laurentiu Dira, Rodica Daniela Nagy, Cristina Comanescu, Dominic-Gabriel Iliescu (Romania)
-
- PP78 Ductus Venosus Agenesis and Portal System Anomalies. Association and Outcome
Nagy Rodica, Nicolae Cernea, George-Lucian Zorila, Roxana Cristina Dragusin, Laurentiu Mihai Dira, Dominic Gabriel Iliescu (Romania)
-
- PP79 Prenatal Diagnosis And Outcome of Umbilical-Portal-Systemic Venous Shunts. Experience of a Tertiary Center and Proposal For a New Complex Type
Nagy Rodica, Dominic Gabriel Iliescu (Romania)
-
- PP80 Fetal Screening Ultrasound - The Evaluation of the Fetal Heart Valves
Cristina Comanescu, Alexandru Cristian Comanescu, Ileana Drocas, Anca Istrate-Ofiteru, Dan Ionut Baluta, Stefan Gabriel Ciobanu, Dominic Gabriel Iliescu (Romania)
-
- PP81 Hysterosalpingo Contrast Sonography (Hycosy) in Utero-Tubal Patency Assessment
Lucian Zorila, Anca Maria Istrate Ofiteru, Elena Iuliana Anamaria Berbecaru, Roxana Cristina Dragusin, Rodica Daniela Nagy, Dominic Gabriel Iliescu (Romania)
-
- PP82 Fetal Growth Restriction: Assessment and Management – Experience in a Tertiary Center
Dinu Marina, Andreea-Denisa Hodorog, Andreea-Florentina Stăncioi-Cismaru, Raluca Aron, Florentina Manolache, Stefania Tudorache (Romania)
-
- PP83 The Role Of Ultrasound in The Multimodal Imaging Diagnosis of Ovarian Cancer
Satoko Arai, Shinichi Tate, Kyoko Nishikimi, Akiyo Takada, Makio Shozu (Japan)
-

-
- PP84 Tomographic Ultrasound New Imaging Technology by Veins Assessment
Tomasz Kardacz
(Poland)
-
- PP85 Value of Doppler Ultrasound in the Diagnosis of Dialysis Fistula-Related Vascular Complications and in the Qualification Patients for Endovascular Treatment.
Mateusz Cheda, Anna Drelich-Zbroja, Maryla Kuczyńska, Zuzanna Paluch, Michał Sojka, Tomasz Jargiełło
(Poland)
-
- PP86 Ultrasound Tomography by Carotid Plaque Assessment. New Visual Technology.
Tomasz Kardacz
(Poland)
-
- PP87 Monitoring Renal Artery Embolization- Role Of Ultrasound
Gliga Mirela, Adriana Gomotirceanu, Lucian Marginean, Mihai Gliga, Paula Maria Chirila, Cristian Chirila
(Romania)
-
- PP88 Low Serum MMP-9/TIMP-1 Ratio is Associated with Extracranial Artery Stenosis in Type 2 Diabetes Mellitus
Yi-Mei Wang
(Chinese Taipei)
-
- PP89 The Use of New Contrast Agents for Ultrasound Tomography
Tomasz Kardacz
(Poland)
-
- PP90 The Relationship Between Coronary and Carotid Atherosclerosis in Patients with Rheumatoid Arthritis.
Olga Alekseeva, Elena Gerasimova, Tatyana Popkova, Irina Kirillova, Olga Fomicheva
(Russian Federation)
-
- PP91 Hypertension in Young People- How a Radiologist Can Help?
Weronika Cyranka, Anna Drelich-Zbroja, Magdalena Woźniak
(Poland)
-

-
- PP92** Virtual Autopsy and Confirmation of Fetal Heart Anatomy and Abnormal Aspects in the First Trimester Using Three-Dimensional (3d) Reconstruction of Histological Sections
Dan Ruican, Ana-Maria Petrescu, Daniel Pirici, Anca-Maria Istrate-Ofițeru, Mircea Serbanescu, Dominic Gabriel Iliescu (Romania)
-
- PP93** Optimization of a Sonication Vessel for Therapeutic Ultrasound Experiments in Vitro
Martin Snehota, Jaromir Vachutka, Marketa Kolarikova, Klara Balazova, Barbora Hosikova, Hana Kolarova (Czech Republic)
-
- PP94** Sonication Vessels for in Vitro Experiments – Real Profile of Ultrasound Field
Klara Balazova, Martin Snehota, Jaromir Vachutka, Barbora Hosikova, Hana Kolarova (Czech Republic)
-
- PP95** The Functional Assessment of the Parotid Glands in Healthy Subjects using the Novel Shear-Wave PLUS Elastography and Viscosity PLUS Techniques
Delia Muntean, Manuela Lenghel, Raluca Balea-Petea, Anca Ciurea, Carolina Solomon, Sorin Dudea (Romania)
-
- PP96** Ultrasound Navigation of Local Corticosteroid Administration in Peroneal Tunnel Syndrome of Common Fibular Nerve.
Nelassov N., Zubov A., Paleonyy A., Stefanenko A., Kutia A., Paleonaya E. (Russian Federation)
-
- PP97** Changes in Thyroid Nodules Caused by Covid-19, According to Ultrasound. First Observations.
Zubov A. D., Zubov A.A., Zyatieva A.P. (Ukraine)
-
- PP98** Frequency and Consequences of Sonographic Incidental Findings in Elderly Hospital Patients in Brandenburg - Establishment of a Prospective Register
Lina Anna Finkensiep, Christian Jenssen, Dieter Nürnberg (Germany)
-

-
- STUCPP99 Indispensable role of handheld ultrasound in rural palliative care
David Boten, Hendra Lo, Christian Jenssen, Dieter Nürnberg
(Germany)
-
- STUCPP100 Augmented reality application for ultrasound equipment knobology
Argus Christian Kollmann, Lukas Santner
(Austria)
-
- STUCPP101 Experiments supporting teaching thermal aspects involved with diagnostic ultrasound output
Christian Kollmann, Jennifer Kinsler, Lee Yongjun
(Austria)
-
- STUCPP102 A rare case of tertiary hyperparathyroidism in a stage 5 chronic kidney disease patient- role of ultrasound examination
Andrei Felea, Teodora Savin, Ana Maria Medesan, Cristian Chirila, Mirela Gliga
(Romania)
-
- STUCPP103 An uncommon ultrasound association: horseshoe kidney and carcinoma
Teodora Savin, Andrei Felea, Ana Maria Medesan, Cristian Chirila, Mirela Gliga
(Romania)
-

Recommendations for speakers and moderators

RECOMMENDATIONS FOR SPEAKERS

In order to plan an effective presentation, please **follow the technical specifications**:

- Please bring your presentation on the following media: **USB stick or external hard drive** (It is also advised to have your presentation stored in an online cloud).
- Power Point versions that can be used is **2019**.
- Save with the extension **.ppt, .pptx**. Do not use the function pack & go. Make sure that all files with movies are embedded in the presentation.
- Please do not use flash animations
- Do not use passwords for files.
- We recommend the use of common fonts: **Times New Roman, Calibri, Verdana, Arial**.
- In order to prevent any difficulties **please have your personal laptop with you**.

Presentation

- **First slide after the titles' slide should contain the disclosure**, if any.
- **All speakers must check-in with the technician at the Praga Speakers Ready Room a minimum of 3 hours before the start of the session – earlier if possible to upload the presentations**. You are welcome to upload your slides the day before your presentation too The Praga Speakers Ready Room will be opened Tuesday 24 May 2022 between 17.00-20.00 and from Wednesday to Saturday during the congress hours.
- Presentation remains the property of the author and will not to be

used without his permission

- Please arrive in time in the conference room before the start of your presentation
- Tell the moderator any details of your work and familiarize yourself with remote control projector, the timer and the microphone
- Strictly follow the instructions of the moderator

RECOMMENDATIONS FOR MODERATORS

Dear colleagues,

The scientific committee thank you for your accept in moderating one or more sessions of the congress. You have a very important role in assuring the success of this event.

We hope that the following information will help you.

Before the session:

- Identify the Conference Hall where the session will be held and reach it with a few minutes before work.
- Meet with technical assistant in charge of this room. If you encounter any problem, please ask technical assistant to help you in this regard.

During the session:

- Remember your audience from switching their phones on silent mode.
- Start the session on time, even if participation is low.
- Do not accept violations of presentation time.

Announcements:

- It is not permitted the filming or photography during the session, other than the official ones.
- Let know the changes that have been supplied by the organizers (if any).

General information



LOCATION AND DATE

Timisoara Convention Center
Marasesti street, no. 1-3, 300086,
Timisoara, Romania
May 25-28, 2022



ORGANIZERS

- World Federation for Ultrasound in Medicine and Biology
- European Federation of Societies for Ultrasound in Medicine and Biology
- Romanian Society of Ultrasound in Medicine and Biology



OFFICIAL LANGUAGE

Presentations will be held in English.



CERTIFICATE OF ATTENDANCE

Each participant will receive a Certificate of attendance, which will be sent by e-mail or downloaded from the MedEvents online platform.

Participants will only be able to receive their certificate of attendance once they have participated in the sessions of the congress.



ACCREDITATION

The WFUMB Congress 2022, will be accredited by the European Accreditation Council for Continuing Medical Education (EACCME®) with **19 European CME credits** (ECMEC®s).



INFOSTAND

The Congress InfoStand will be located in the lobby of the Timisoara Convention Center building.

The working schedule will be:

- Tuesday, May 24th 2022
15:00 – 20:00
- Wednesday, May 25th 2022
08:00 – 18:00
- Thursday, May 26th 2022
08:00 – 18:00
- Friday, May 27th 2022
08:00 – 18:00
- Saturday, May 28th 2022
08:00 – 14:00



HANDBOOK PROGRAMME

Each participant will receive from the InfoStand the Program Handbook. Program Handbook includes congress and partner materials.



BADGES

Participants are requested to wear their badge at all times while inside the congress center.



CONGRESS ACCESS

For access in the presentation room you will be using the badge which you will receive after registering at the InfoStand. Participants will choose their seats on “first come, first serve” basis. Therefore, we recommend to plan for an early arrival at the premises.



MEDIA POLITICS

Photography and filming during the congress are prohibited without written permission from the event Media Coordinator, whom you can contact at the InfoStand.



CATERING

Participants will serve the coffee breaks/lunch in the designated spaces, as detailed in the Program Handbook.



ELECTRICITY

The electricity in Romania runs on 230 volts and the frequency is 50 Hz. Plugs have two round pins. A plug adaptor will be required if incompatible electronic devices are used.



INFORMATION FOR SPEAKERS

There will be accepted for presentation only the digital materials which respect the technical specifications agreed upon registration. The materials need to be dropped at Praga Speakers Room at least 3 hours before the time scheduled for your presentation. Not being able to respect the technical specifications or the time limit could have a negative impact on your presentation.



DRUGS AND FIRST AID

A wide range of non-prescription drugs are readily available at local pharmacies. For other medication you will need a prescription signed by a registered Romanian doctor. In case of emergency please call the 112 emergency number.



LIABILITY AND INSURANCE

The congress operator will not assume responsibility for injury and/or damage involving persons or property during the event. All participants are advised to prevent/avoid any injury/ loss.



MOBILE PHONE

Mobile phones must be switched off during all sessions.



SMOKING

Smoking is allowed only in designated areas.



LOST AND FOUND

Lost property can be taken at the InfoStand. To report a lost item please contact the InfoStand.



PROFESSIONAL CONGRESS ORGANISER

CONTACT
wfumb2022@medevents.ro

10 Reasons to Visit Timisoara

With its rich history, vibrant cultural scene, lively terraces and cafés and robust student population, Timișoara, the 2021 European Capital of Culture is Romania's must-visit city right now. Here are our 10 reasons why you should add Timișoara to your destination list on your next visit to Romania.

Fascinating history



Timișoara has been inhabited since ancient times, by Dacians and later the Romans, who named it *Castrum Temesiense*. First mentioned in 1212 as a citadel, by the 14th century it became an important outpost in the fight between Christendom and the Muslim Ottoman Turks. It was here that Hungarian and French crusaders gathered before the Battle of Nicopolis (1396), one of the last large scale crusades. From the 18th century, it

developed around the fortified nucleus and later transitioned towards becoming an important economic and industrial centre. The city flourished between the interwar period and the Communist period, when its population tripled.

On 22 December 1989, following a popular uprising, Timișoara became the first Romanian city free of communism, starting the Romanian Revolution which toppled Ceaușescu's regime.

Electrifying past

In 1884 Timișoara was the first mainland European city and just second in the world – after New York – to have electric public street lighting. After the city's contract with the Viennese company that supplied it with the gas used for lighting ended, the city decided to take a shot on a new revolutionary public lighting system. On 12 November, 731 electric lamps were used to light the streets of Timișoara, paving the way for its bright future. The two lamps in front of the Huniade Castle, hosting the Banat Museum, are a reminder of just that.

The capital of the Banat region was also the second European city, and first in Romania, to introduce horse-drawn trams in 1869.



**Huniade
Castle, E671,
Timișoara,
Romania**

Lively cultural scene

The third most populous city in Romania, Timișoara has no less than four theatres, namely the Mihai Eminescu National Theatre, the German State Theatre, the Csiky Gergely Hungarian State Theatre, and the

Merlin Puppet Theatre.

The city also has several museums hosted by some of Timișoara's landmark buildings. The Art Museum, hosted by the Baroque Palace in the Unirii Square, the Banat Museum that occupies the Huniade Castle, and the open-air Museum of Banat Village are not to be missed. The Palace of the Serbian Episcopacy offers a surprisingly well curated collection of art and rare books. Plus, Timișoara also has an Opera, a Philharmonic, plenty of art galleries and hosts over 30 festivals every year.



Museum of Banat Village, Strada Avram Imbroane 1, Timișoara 300136, Romania

University center

Ever since King Ferdinand I awarded Timișoara the status of University centre in 1920, the city has attracted the brightest minds in the country and beyond.

Timișoara now has four public universities and as many private ones. The student population of the city, totalling around 60,000 students, lends the city a fresh, youthful vibe.

2021 European Capital of Culture

In September 2016, Timișoara was elected 2021 European Capital of Culture, a title it shares with Novi Sad in Serbia and Eleusis, Greece. For one calendar year, the city will host a series of cultural events with

May 25-28, 2022
Timisoara, Romania

wfumb2022.com

a European dimension, such as exhibitions, concerts, plays and many more.



True multiculturalism

Throughout its history, Timișoara has been a melting pot of cultures. An important Muslim community in the 17th century during Ottoman rule, and later, Hungarians, Serbs, Germans and Jewish all called the city their home.

Currently, the Romanian Opera House, the imposing building in Victoriei Square, hosts the Opera, as well as the Mihai Eminescu Romanian National Theatre, the German State Theatre and the Csiky Gergely Hungarian State Theatre. Moreover, services at the Catholic Dome are held even today in Romanian, Hungarian and German languages.



**Romanian Opera House,
(Piața Operei)**

**Piața Victoriei
Timișoara, Romania**

Stunning architecture

Timișoara's architecture is the first thing that stands out when it comes to the city's rich cultural heritage.

Standing tall at 80 meters, with its 11 towers, and seven bells, the Timișoara Metropolitan Cathedral is one of the most imposing buildings in the city. Its cupola is built in Moldavian style, while the side arches are in Byzantine style and the mosaic floors recreate motifs found in Banat style rugs. The City Hall and the Neuhaus Palace, designed by talented Hungarian-born architect Laszlo Szekely, add to the list of architectural landmarks of the city.

The Catholic Dome is the most important Baroque monument in the Banat region. Its sumptuous interior features nine altars decorated in rococo style, made by Viennese painters and sculptors. Not least, Art Nouveau buildings are scattered all around the area of the former citadel. The Dicasterial Palace, hosting the Palace of Justice, is a copy of the Palazzo Medici in Florence.



**Timișoara
Metropolitan
Cathedral,
Bulevardul
Regele Ferdinand I,
Timișoara, Romania**

Amazing food

The city's old centre is full of cafés, restaurants and ice cream parlours catering to all tastes. The highlights of the Banat cuisine, such as pork specialties, as well as plenty of deserts will provide you with a hearty

May 25-28, 2022
Timisoara, Romania

wfumb2022.com

meal after a day full of sightseeing.

Mild weather

Timișoara has mild weather all year round, thanks to its Marine West Coast Climate. This means that usually, at the height of summer, the city is spared the hot and dry days Bucharest and other cities in the Romanian Plain are known for. In winter, temperatures do not drop sharply, making the city an enjoyable destination to be explored by day and by night.

Wild nature

Timișoara has plenty of parks as well as its own Botanical Gardens. However, the natural areas around the city are where you can spot the most spectacular wildlife in the region. To combine outdoor activities and birdwatching, a canoe trip on the Bega river will provide you with the right setting. A longer trip, of around two and half hours will take you to Cheile Nerei, one of the most beautiful national parks in Romania.



**Botanical
Gardens,
Calea
Alexandru
Ioan Cuza,
Timișoara,
Romania**

SOURCE

theculturetrip.com/europe/romania/articles/10-reasons-to-visit-timisoara

PLATINUM



GE Healthcare



MEDIST
Imaging

GOLD



LIFE FROM INSIDE

The Swiss concept in pharmaceuticals

mindray



SAMSUNG
MEDICAL

SILVER PLUS

SIEMENS
Healthineers

BRONZE

Canon
CANON MEDICAL

FUJIFILM
Value from Innovation

LIAMED (CO)
APARATURA MEDICALA | ERASOV

temco
MEDIUM LIFE | MEDICAL EQUIPMENT OF ROMANIA

MEDIO
connecting people with
medical innovation

DTL MEDICAL
Diagnosis, Treatment, Life

PONDERA MEDICAL
Smart Solutions for Smarter IDE

wörwag
PHARMA

PARTNERS



Sun Wave Pharma
Making Tomorrow Healthier

Terapia
a SUN PHARMA company

Labormed
O COMPANIE ZENTIVA



Timișoreana



PROFESSIONAL CONGRESS ORGANIZER

phone +40 364 146 681

fax +40 364 108 990

Cluj-Napoca 400012

3/3 Victor Babes Street

contact@medevents.ro

www.medevents.ro



wfumb2022.com